

1 Description

The DP-Hub (10DPHUB) is a programmable lockout module used for any automatic swing door in conjunction with the EDPS, Enhanced Door Position Sensor, (10EDPS) to provide accurate door position. The accurate door position provides:

- Automatic inhibiting of the safety side Door Mounted Sensor(s) without the need for an external mechanical limit switch.
- A manual push of the door or stack pressure will no longer effect the overhead presence.

The hub also provides sensor plug-in connectors, and easy 2-button digital programming with a user-friendly display. The DP-Hub product line is identified by a solid black housing.



2 Specifications

DESCRIPTION	SPECIFICATION	COMPONENT INPUTS	COMPONENT OUTPUTS
Supply voltage	12 to 24 VAC/VDC: +/- 10%	(2) Eagle Motion Sensors (1) BodyGuard Sensor */** (2) Pair of Door Mounted Sensors w/ EDPS & Home switch (2) Manual Door Mounted Stall Inhibit Terminals (1) Auxiliary: Push Plates, RF, etc. (1) SBK 30 Photo Beam pair (1) ON/OFF/HOLD Switch * For dual egress, use Y-harness for second BodyGuard. ** For independent dual egress, two hubs are required.	(2) Door Control
Power consumption	80mA max. (hub only)		
Temperature range	-20°F to +150°F		
Dimensions	4.5" W x 2.5" D x 1.25" H		
Housing material	ABS – Solid Black		
Relay Specifications	2A, 30 VDC .3A, 110 VDC .5A, 125 VAC		

3 Precautions



- Shut off all power going to header before attempting any wiring procedures.
- Maintain a clean & safe environment when working in public areas.
- Constantly be aware of pedestrian traffic around the door area.
- Always stop pedestrian traffic through the doorway when performing tests that may result in unexpected reactions by the door.
- ESD (electrostatic discharge): Circuit boards are vulnerable to damage by electrostatic discharge. Before handling any board ensure you dissipate your body's ESD charge.
- Always check placement of all wiring before powering up to ensure that moving door parts will not catch any wires and cause damage to equipment.
- Ensure compliance with all applicable safety standards (i.e. ANSI A156.10) upon completion of installation.
- DO NOT attempt any internal repair of the components. All repairs and/or component replacements must be performed by BEA, Inc. Unauthorized disassembly or repair:
 1. May jeopardize personal safety and may expose one to the risk of electrical shock.
 2. May adversely affect the safe and reliable performance of the product resulting in a voided warranty.

4 Pre-Installation Check

1. When preparing to wire multiple devices together for a 'system' configuration, it is best to ensure the correct operation of each device independently before starting thereby reducing troubleshooting time later in the event of a discrepancy. Thus make sure the door is running correctly and adjusted properly before installing Door Position System.
2. Prior to installing equipment on an existing installation or when installing equipment on a new installation, utilizing new electrical supply circuits, always ensure the correct line voltage exists and is stable. Remember to disconnect the power after checking the line voltage and before performing any wiring to the system.

5 Installation

1 Introduction

STEP 1:	Page 2:	Introduction	STEP 11:	Page 6:	Install Auxiliary/Push Plate(s) (optional)
STEP 2:	Page 2:	Install DP-Hub	STEP 12:	Page 7:	Install Photo Beams SBK-30 (optional)
STEP 3:	Page 2:	Install ON/OFF/HOLD Switch	STEP 13:	Page 7:	Install Power Harness
STEP 4:	Page 3:	Install BodyGuard	STEP 14:	Page 8:	Configure BodyGuard III
STEP 5:	Page 3:	Install Door Control Harness(s)	STEP 15:	Page 8:	Check Function Number of Doors on DP-Hub
STEP 6:	Page 4:	Install Door Mounted Sensor(s)	STEP 16:	Page 9:	Perform Door Position System Learn
STEP 7:	Page 4:	Install EDPS(s)	STEP 17:	Page 9:	Perform Walk Test
STEP 8:	Page 5:	Install Home Switch			
STEP 9:	Page 5:	Door Mounted Safety Side Manual Inhibit (optional)			
STEP 10:	Page 6:	Install Eagle(s) (optional)			

CONNECTION DIAGRAM:

- 1 Door Mounted 1
- 2 Door Mounted 2
- 3 BodyGuard
- 4 Eagle 1
- 5 Eagle 2
- 6 Power
- 7 SBK-30 Beams
- 8 Auxiliary/Push Plate(s)
- 9 ON/OFF/HOLD Switch
- 10 Programming - FUNC (Function)
- 11 Programming - INCR (Increment)
- 12 Learn/Home/Tracking LEDs
- 13 Safety/Stall/Activation LEDs
- 14 Door Control 2
- 15 Door Control 1
- 16 Door Mounted 2 Manual Inhibit
- 17 Door Mounted 1 Manual Inhibit

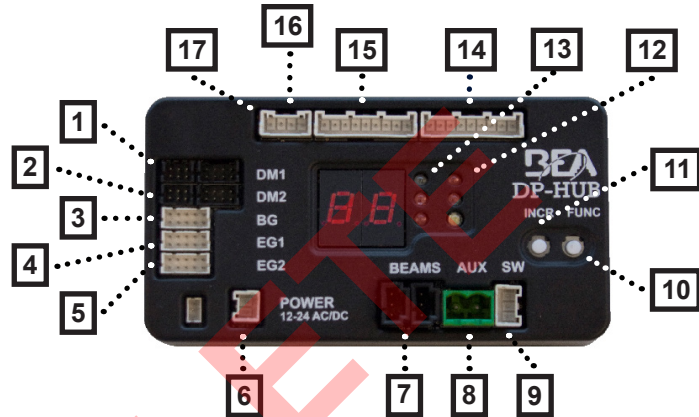

INSTALLATION HARNESSSES:

BEA P/N:	DESCRIPTION:
20.5078.02	ON/OFF/HOLD Switch Harness
20.5082	BodyGuard Harness
20.5083	BodyGuard Y Harness (optional for dual egress pair)
20.5222	Door Control Harness
20.5215.02	Door Mounted/EDPS Harness
20.5096	Eagle Harness
20.5095	Power Harness

2 Install DP-Hub

1. Install the DP-Hub in an accessible location inside the door header using supplied velcro strips. Allow adequate space to easily see the DP-Hub display, to access the push buttons and to access all connectors.

3 Install ON/OFF/HOLD Switch

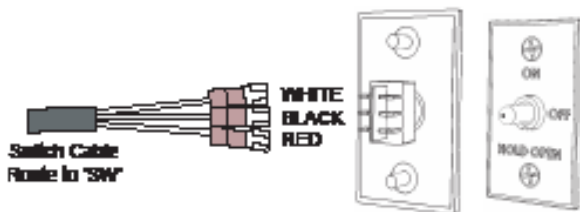

When upgrading from an LO-Linx make sure that the wire colors are in the order shown above, as the LO-Linx was packaged with a different model ON/OFF/HOLD Switch.

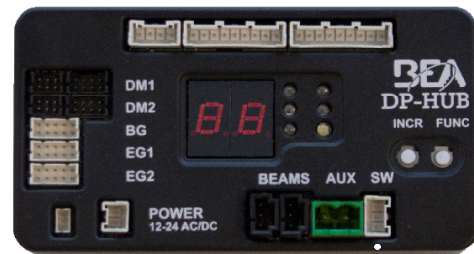

ON/OFF/HOLD Switch

1. Install ON/OFF/HOLD Switch in desired location. Ensure the location is easily accessible.
2. Route wiring harness (20.5078.02) from ON/OFF/HOLD Switch to DP-Hub and plug into DP-Hub at location marked 'SW'.

NOTE: When changing the state of the ON/OFF/HOLD switch, the door will not open or close if the Bodyguard is in detection.

NOTE: If the door control also has an ON/OFF/HOLD switch, make sure to jump it to the ON position and use the BEA ON/OFF/HOLD Switch.

5 Installation (continued)

4 Install BodyGuard

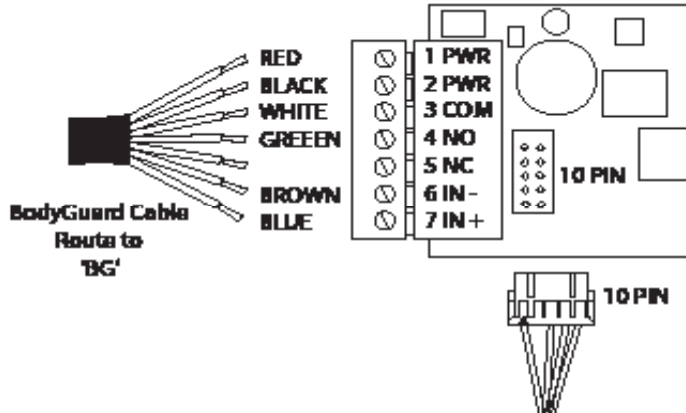

1. For complete installation instructions refer to BodyGuard User's Guide (75.5134).

NOTE: BEA recommends the use of the Bodymount during all Bodyguard installations.

NOTE: On a single door installation the Bodyguard should be angled to 10 degrees (5 degrees default).

2. Plug ten pin connector into BodyGuard as shown above (hard wire as shown above only if ten pin connector is not available).
3. Route BodyGuard Cable Harness (20.5082) through door header to DP-Hub.
4. Plug BodyGuard Cable into DP-Hub at location labeled 'BG'.

NOTE: For dual egress use Y-harness for second BodyGuard.

NOTE: For independent dual egress, two DP-Hubs are required.

NOTE: BodyGuard Jumper (BodyGuard plug with orange jumper wire) can be used to setup the system when the BodyGuard is on the door header cover. It can also be used in low energy applications.

5 Install Door Control Harness(s)

The DP-Hub provides two door control outputs for door controls that cannot be paralleled together.

WIRE	OUTPUT	'TYPICAL' DOOR CONTROL
Green	Activation NO	ACTIVATION
Yellow	Activation NC	
White	Activation COM	COM
Green/Black	Safety NO	SAFETY
Yellow/Black	Safety NC	
White/Black	Safety COM	COM
Green/Red	Stall NO	STALL
Yellow/Red	Stall NC	
White/Red	Stall COM	STALL COM

For a list of specific door control connections please refer to Appendix B.

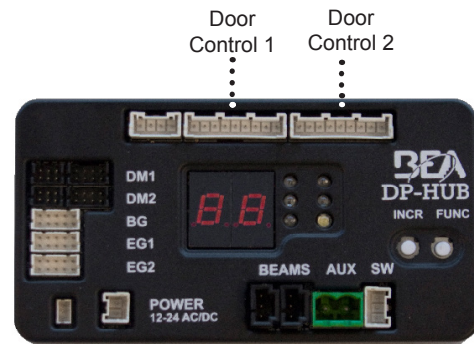

1. Make connections to the door control(s) as displayed above.
2. Route wiring harness(s) (20.5222) from door control to DP-Hub and plug into DP-Hub at location marked 'CONTROL 1' and/or 'CONTROL 2'.

NOTE: Typically on the door control, the common (COM) for the Stall input is isolated from the common for Activation and Safety. If the door control has one common input, tie all the common outputs from the DP-Hub together.

5 Installation (continued)

6 Install Door Mounted Sensor(s)

(SuperScan shown in example)

Door Mounted 1 Cable
Route to 'DM 1'

Door Mounted 2 Cable
Route to 'DM2'

Make sure to set the SuperScan's JP2 to the default (as shown) to make the SuperScan have a closed contact during detection.

Door Mounted 1
Door Mounted 2

DM1
DM2
BG
EG1
EG2
BEAMS AUX SW
POWER 12-24 AC/DC
BEA DP-HUB INCR FUNC

1. For complete installation instructions refer to **appropriate** Door Mounted Sensor User's Guide (SuperScan or QuadScan). **For a new install, please make sure to use the DPS Door Mounted Sensor Extrusion Mounting Template**, in order to get the extrusion(s) with end caps installed, approximately 1" apart. For a retro fit where the 1" apart cannot be obtained or for more precise Home Switch installation, please refer to Appendix C.
2. Wire Door Mounted Sensor (SuperScan displayed in this example) harness labeled **APPROACH** to the approach/push side Door Mounted Sensor.
3. Wire Door Mounted Sensor harness labeled **SAFETY** to the safety/swing side Door Mounted Sensor.
4. Route wiring harness (20.5215.02) from the Door Mounted Sensor to DP-Hub and plug into DP-Hub at location marked 'DM1'. Also note that the extra ten pin connector on the harness should also be routed to the **safety side** of the door as it will be used for the EDPS installation in Step 7.

For a two door system, repeat steps above with the **second door**, except route the second wiring harness from the Door Mounted Sensor to DP-Hub and plug into DP-Hub at location marked 'DM2'.

NOTE: If the door system has reflective guide rails (for example; stainless steel) set the hold time on the safety side door mounted sensor(s) to approximately one second.

7 Install EDPS(s)

SuperScan EDPS SuperScan

SuperScan (shown in example)

10 pin plug from
Door Mounted Sensor Cable

1. Install the EDPS (Enhanced Door Position Sensor) into the **safety side** Door Mounted Sensor extrusion as close to the center as possible as shown above with SuperScans.
2. Plug the previously routed ten pin connector in Step 6 from wiring harness (20.5215.02) into EDPS as shown above.

For a two door system, repeat steps above with the second door.

NOTE: When the DP-Hub is powered the EDPS green LED will illuminate to let you know that it is powered.

NOTE: The EDPS must be placed at the 0 degree angle (horizontal) in the clips as shipped.

5 Installation (continued)

8 Install Home Switch



End cap with Home Switch Collar exploded

Magnetic reed switch wired into EDPS



Surface Mount Adapter exploded and Installed



Magnet installed in end cap exploded and installed

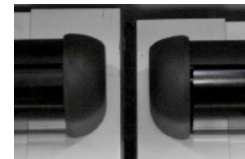

1. Snap the Home Switch Collar with the magnetic reed switch into the correct end cap and install the end cap on the Door Mounted Sensor extrusion. For a one door system, the correct end cap will be the cap on the leading edge of the door. For a two door system, the correct end cap will be the leading edge or either door. The default installation will have the magnetic reed switch flush with the collar, however some adjustment may be required. **For a new install, please make sure to use the DPS Door Mounted Sensor Extrusion Mounting Template**, in order to get the extrusion with end cap installed approximately 1" apart from the surface mount adapter. For a retro fit where the 1" apart can not be obtained or for more precise Home Switch installation, please refer to Appendix C.
2. Route the two wires from the magnetic reed switch to screw terminal on the previously installed EDPS ensuring that the wires are out of the Door Mounted Sensor's pattern (orientation of the two wires to the screw terminal does not matter).

For a **typical** one door system:

3. Press the supplied magnet into the top piece of the surface mount adapter.
4. Press the top and bottom pieces of the surface mount adapter together and install on the door jamb, using the two screws as shown above. **For a new install, please make sure to use the DPS Door Mounted Sensor Extrusion Mounting Template**, in order to get the extrusion with end cap installed approximately 1" apart from the surface mount adapter. For a retro fit where the 1" apart can not be obtained or for more precise Home Switch installation, please refer to Appendix C.

For a **typical** two door system:

3. Snap the supplied magnet into the second Door Mounted Sensor extrusion end cap and install the end cap on the Door Mounted Sensor extrusion.

If you cannot use the **typical** installation, there are several alternatives. For more Home Switch information please refer to Appendix C.

9 Door Mounted Safety Side Manual Inhibit (optional)

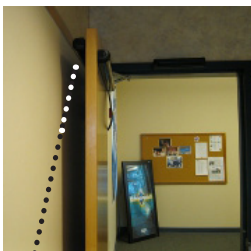

Door Mounted Sensor needs inhibited automatically by DP-Hub or manually

Door Mounted Sensor Manual Inhibit Jumper

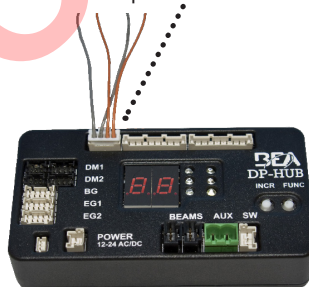

Door Mounted 1 Manual Inhibit
Door Mounted 2 Manual Inhibit

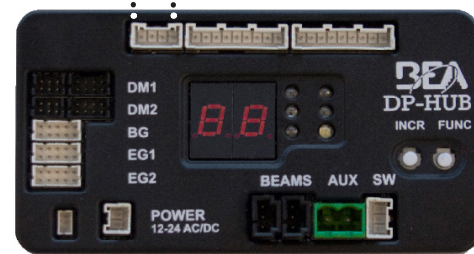

Manually inhibiting the Door Mounted Safety Side Sensor(s) is completely optional due to the fact the DP-Hub will automatically learn the location at which those sensor(s) go into detection during the learn cycle and then inhibit them during all consequent cycles. However if preferred to manually inhibit those sensors using a mechanical limit switch, there are two positions available on the DP-Hub. The switch(es) must open its contacts at the desired point of inhibiting. When these terminals are not used, they should be jumpered using the jumper included with the package. If manually inhibiting of a Door Mounted Safety Side Sensor(s) is desired at some point in the opening cycle:

1. Cut the grey jumper wire for 'MANUAL Stall Inhibit 1'.
2. Wire the mechanical inhibit switch to the previously cut jumper wires and wire nut.

For a two door system, repeat steps above using the orange jumper wire.

NOTE: See Programming Parameter F_{11} on page 10 section 6-1.

5 Installation (continued)

10 Install Eagle(s) (optional)

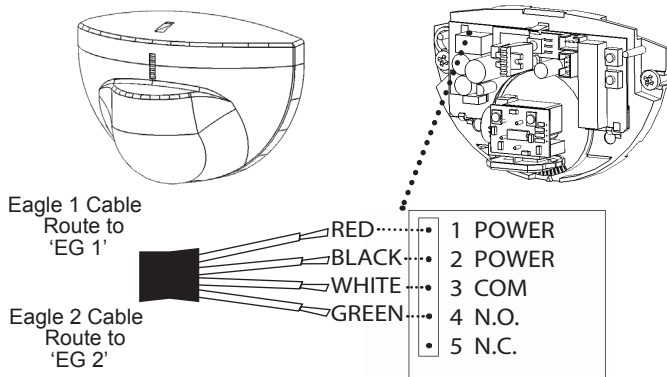

1. For complete installation instructions refer to Eagle User's Guide (75.0058).
2. Wire Eagle as displayed above.
3. Mount Eagle Sensor to door header and route Eagle harness (20.5096) through door header and plug into DP-Hub at location marked 'EG1'.

For two way traffic, repeat the steps above on the opposite side of the door and plug into DP-Hub at location marked 'EG2' and make sure that the Eagle is installed beyond the swing of the door so that the normal operation of the door does not trigger the Eagle.

11 Install Auxiliary/Push Plate(s) (optional)

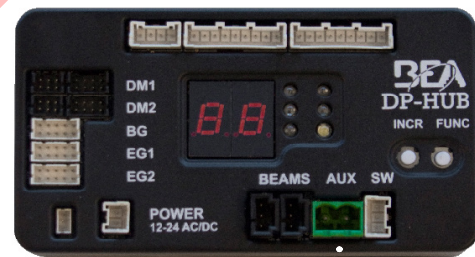
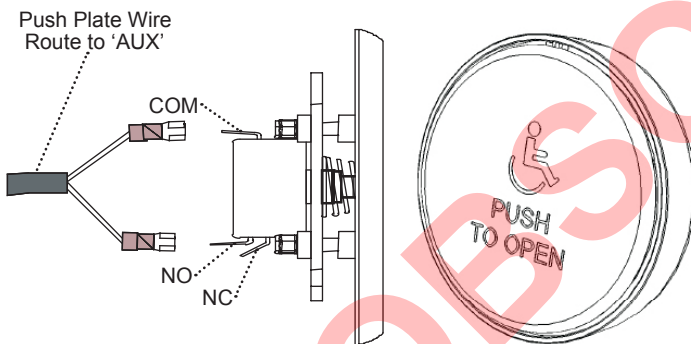

Auxiliary/Push Plate

1. Mount Push Plate(s) or other Knowing Act device(s) to wall, jamb or desired location accessible to traffic flow.
2. Route two wires from Push Plate to DP-Hub and fasten one leg of Push Plate at the first location of screw terminal marked 'AUX' on DP-Hub and the second leg of Push Plate to second location marked 'AUX' on DP-Hub.

NOTE: Make sure the device is wired to the normally-opened (NO) and common (COM) contacts of the device.

NOTE: See Programming Parameter FR on page 10 section 6-1.

5 Installation (continued)

12 Install Photo Beams SBK-30 (Optional)

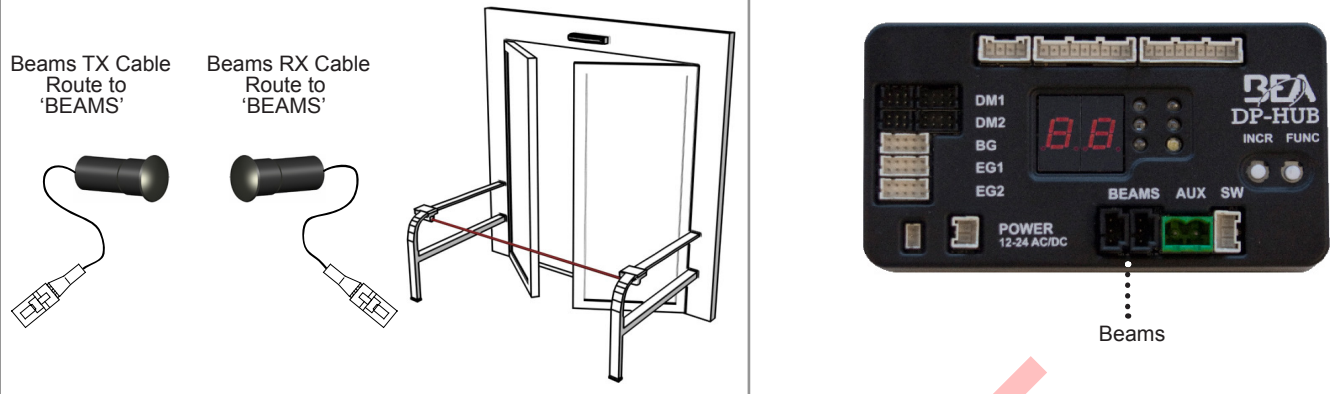

1. For complete installation instructions refer to Beams SBK-30 Users Guide (75.5179).
2. Install Beam Transmitter.
3. Install Beam Receiver.
4. Route wiring harness (20.5099) from the Transmitter to DP-Hub and plug into DP-Hub at either one of the locations marked 'BEAMS'.
5. Route wiring harness (20.5100) from the Receiver to DP-Hub and plug into DP-Hub at the other location marked 'BEAMS'.

NOTE: See Programming Parameter Fb on page 10 section 6-1.

NOTE: If using beams, the DP-Hub will automatically be set to Advanced BodyGuard Safety.

13 Install Power Harness

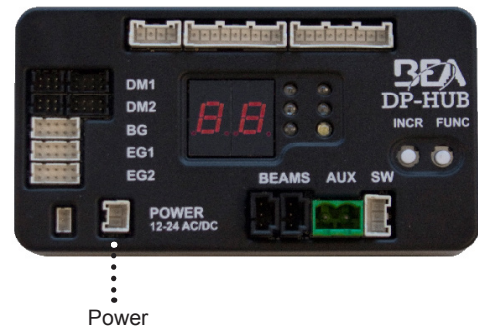
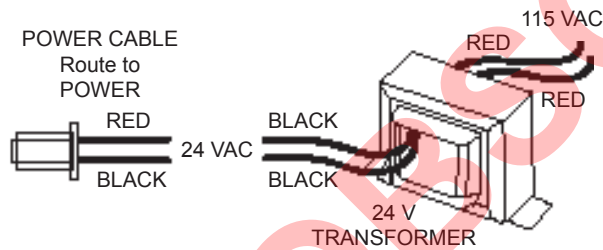





1. Install transformer in an easily accessible location to the DP-Hub.
2. Route wiring harness (20.5095) from the Transformer to DP-Hub and plug into DP-Hub at location marked 'POWER'.

NOTE: Always use the BEA supplied transformer and **never** power the DP-Hub from the door control.

5 Installation (continued)

14 Configure BodyGuard III

BODYGUARD III

1. Unlock BodyGuard Sensor 
2. Set Output Configuration  to  Normally Closed
3. Lock Sensor by pressing Lock  twice

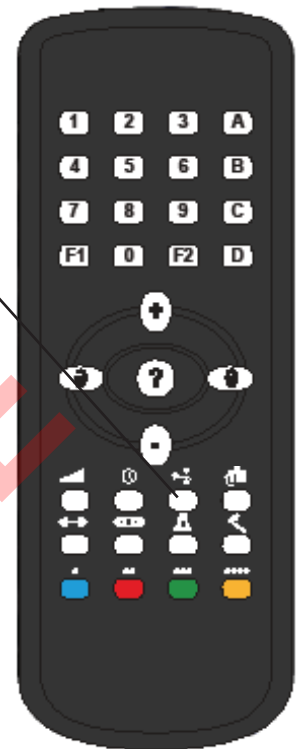
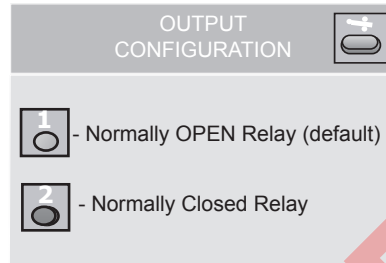
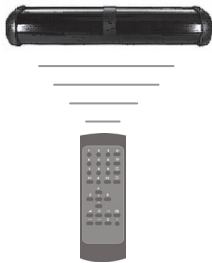

CAUTION: When using the remote control to adjust the Bodyguard, make sure you do not accidentally change the settings on any other sensors.

NOTE: You may or may not need to adjust the BodyGuard pattern width. For instance if you are using a one door system, you must set the pattern to 'Center Narrow'. However if you are using a two door system, the default BodyGuard pattern will suffice. Please refer to BodyGuard User's Guide (75.5134) as necessary.

15 Check Function Number of Doors on DP-Hub

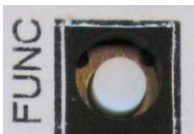

$Fd = 01$
ONE DOOR

$Fd = 02$
TWO DOORS

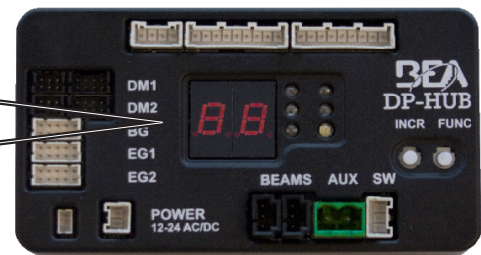

One door system:

1. Set 'FUNC' Fd to 'INCR' 01 by first pressing the 'FUNC' button until DP-Hub display shows Fd then press 'INCR' button until display shows 01 .

Two door system:

1. Set 'FUNC' Fd to 'INCR' 02 (default) by first pressing the 'FUNC' button until DP-Hub display shows Fd then press 'INCR' button until display shows 02 .

NOTE: The above step for showing how to check and/or change a function is the same procedure for checking all functions listed in Section 6 - Programming the DP-Hub. Please check all Programming Parameters in Section 6 before proceeding to Step 16 - Perform Door Learn. In most applications, changing Fd will be the only necessary adjustment.

5 Installation (continued)

16 Perform Door Position System Learn

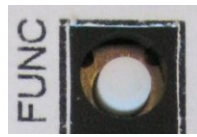

Ln
LEARN MODE

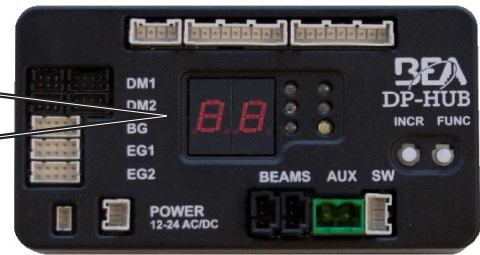

After all of the programming has been performed to the DP-Hub, make sure that there is **NO** pedestrian traffic for approximately two minutes and:

1. Make sure orange Home LED is on. Make sure the ON/OFF/HOLD Switch is set to ON. Then set the DP-Hub into Learn Mode by first pressing the 'FUNC' and 'INCR' buttons simultaneously until the blue LED comes on and then release both buttons. After two seconds (in which the DP-Hub will learn the EDPS baseline) the DP-Hub display shows Ln.
2. Activate the door(s) by holding activation on either the Push Plate(s) or Eagle(s) until the door(s) reaches full open, then release activation and let the door(s) come closed.

NOTE: The DP-Hub is **NOT providing safety on this first cycle** as the DP-Hub is simply learning door position (very similar to most door controls).

If the Learn was successful (approximately twenty seconds) signified as the DP-Hub display shows dP:

3. Activate the door(s) for a second time by holding activation on either the Push Plate(s) or Eagle(s). Make sure that the door(s) reaches full open and that it does **NOT** stall erroneously. This can easily be verified by observing the yellow LED on the DP-Hub. If the yellow LED is lit, the door is going into stall.

If the door(s) reached full open and did **NOT** stall erroneously proceed to Step 17 - Perform Walk Test.

If the door(s) reached full open and did stall erroneously see Section 6 - Programming the DP-Hub, and increase the Function Inhibit Degrees, F_i, and then repeat the Learn.

If the Learn was unsuccessful signified as the DP-Hub display shows Er:

3. Set the DP-Hub to show the operating parameters dE by pressing the 'FUNCT' button until DP-Hub display shows dE and observe the error code(s) that will be displayed by toggling every second. The error codes are described in detail in Section 6 and Section 8.
4. Take the corrective action(s) to fix the error(s).
5. Exit the Display Errors mode, dE, by pressing the 'FUNCT' button until DP-Hub display shows Fd. Wait five seconds for the display to become inactive by showing Er, and then repeat the Learn.

17 Perform Walk Test

1. Make sure that when the door(s) is closed the orange LED for the Home Switch on the DP-Hub is lit. This signifies that the Home Switch is installed correctly.
2. Activate the door(s) several times *from the door closed position*. Make sure that the door(s) reaches full open and that it does **NOT** stall erroneously. This can easily be verified by observing the yellow LED on the DP-Hub. If the yellow LED is lit, the door is going into stall.
3. Re-activate the door(s) several times this time *not letting it make it to the door closed position*. Make sure that the door(s) reaches full open and that it does **NOT** stall erroneously.
4. Make sure that each time the door does reach the closed position that the orange LED for the Home Switch is lit.

If the door(s) did stall erroneously see Section 7 - Programming the DP-Hub, and increase the Function Inhibit Degrees, F_i, and then return to Step 16 - Learn the Door.

4. Test the safety side Door Mounted Sensors to make sure that they will stall the door. Try to stall the door early in cycle to make sure that they are not yet inhibited by the DP-Hub.

NOTE: The DP-Hub will NOT allow the Door Mounted Sensors to inhibit before sixty-five degrees.

5. Test the accuracy of the Home Switch by slowly pushing the door(s) open and observe that the orange LED for the Home Switch turns off before the red LED for Safety turns on. If you get the red LED for safety before the orange LED for the Home Switch turns off, please refer to Appendix C for adjustment of the Home Switch. Once the Home Switch is adjusted correctly, jump back to Step 16.
6. Test a manual push of the door by manually pushing it open and then attempt to activate the door and ensure that it opens (assuming that you have F5 turned off).
7. Test all door safety as required by ANSI 156.10.

6 Programming the DP-Hub

Very little programming is required on the DP-Hub as the default parameters should suffice for most systems. The DP-Hub can display two sets of information to the user. These sets are programming parameters and operating parameters.

1 Programming Parameters (Adjustable)

- The first set of parameters is for programming the hub and allows the user to access and change the values as needed. The chart below explains each function and the possible values for each. For a **typical** application on most operators, the default settings (in bold) should suffice. Once one of the programming parameters has been selected, the display will remain **active for 5 seconds** after the last button has been pressed. The display will then become inactive, which is signified by d^P and the programming parameters will be saved.

NOTE: Function displays are accessed by momentary presses of the 'FUNC' function button and values are changed by momentarily pressing the 'INCR' increment button.

NOTE: Make sure the display shows d^P before completing all work.

DISPLAYS	DESCRIPTION	
F_d	01 = One door system 02 = Two door system	Function Doors - This setting switches between a one door system and a two door system.
F_L	01 = New lockout data 02 = Old lockout data	Function Lockout - This setting switches between Old Data and New Data. New data is required when using QuadScans, otherwise use the default of Old Data.
F_A	00 = Normal Operation 01 = Knowing Act	Function Knowing Act - This setting allows the ability to ignore the Eagle and Approach SuperScan inputs when the door is closed (Quadscans are always off when the door is closed). NOTE: If $F_A = 01$ ensure $F_h = 05$ for ANSI compliance.
F_b	00 = No Beams 01 = Beams Installed	Function Beams - This setting enables use of SBK-30 photoelectric beams.
F_n	00 to 30 - Time in seconds (10 seconds)	Function Not Closed Timer - This setting provides the amount of time that will be required to switch to the 'NOT CLOSED' state. This time is the amount that the door(s) has been allotted by the DP-Hub for it to reach the 'CLOSED' state from 'OPENED' or 'MANUAL' states. F_n is unused when $F_5 = 01$. See F_5 below for further description.
F_{i1}	00 = Automatic Inhibit 01 = Manual Inhibit	Function Manual Inhibit - This setting disables the automatic inhibiting of the Door Mounted Sensors during the opening cycle. The typical reason for performing a manual inhibit is that you are replacing a legacy product that already had the sensors inhibited mechanically by a limit switch and want to keep that installation.
F_i	05 to 10 - Buffer in degrees (07 degrees)	Function Inhibit Buffer - This setting provides the number of degrees that will be used as a buffer to inhibit the safety side Door Mounted Sensors during the opening cycle.
F_P	00 = Normal Operation 01 = Push and Go	Function Push-and-Go - This setting enables Push-and-Go. Push-and-Go is a feature that when the door(s) is started to be pushed manually, the DP-Hub will recognize that push and then send an activation thus making the door(s) run automatically.
F_h	00 to 30 - Time in seconds (01 seconds)	Function Activation Hold Timer - This setting provides the amount of time that a momentary activation will be held on the Activation Output.
F_5	00 = Standard Safety 01 = Advanced Safety	Function BodyGuard Safety - This setting determines the BodyGuard safety level. If this feature is turned off (00), the doors will be allowed to activate when the doors are removed from home (push or stack pressure) when the BodyGuard is in detection. In this state safety will be provided by the SuperScans. However if this feature is turned on (01), the DP-Hub will provide safety and NOT allow the door to activate (similar to our current lockouts).

6 Programming the DP-Hub (continued)

2 Operating Parameters (Troubleshooting)

- The second set of parameters provides a set of real-time operating parameters for troubleshooting. These displays are available only to view, with no user interaction possible. They merely provide the operating status of the system. The chart below shows these displays. Once one of these operating parameters has been selected, the display will remain active on that parameter and **NOT time out**, thus NOT saving any programmed parameters until one of the programming parameters has been selected.

DISPLAYS	DESCRIPTION									
<i>d^r</i>	Display Relay – Displays the active DP-Hub relay(s):									
	<table border="0"> <tr> <td><i>R_c</i> - Activation</td> <td>55 - Stall</td> </tr> <tr> <td><i>S_F</i> - Safety</td> <td>-- - None</td> </tr> </table>	<i>R_c</i> - Activation	55 - Stall	<i>S_F</i> - Safety	-- - None					
<i>R_c</i> - Activation	55 - Stall									
<i>S_F</i> - Safety	-- - None									
<i>d^d</i>	Display Door – Displays current state of door:									
	<table border="0"> <tr> <td><i>o^P</i> - Opening</td> <td><i>d_c</i> - Closed</td> </tr> <tr> <td><i>d_o</i> - Opened</td> <td><i>c_L</i> - Closing</td> </tr> <tr> <td><i>h_o</i> - Hold Open (3-position switch in 'H/O' position)</td> <td><i>o_F</i> - Off (3-position switch in 'OFF' position)</td> </tr> <tr> <td><i>n_n</i> - Manual (door(s) was pushed open manually)</td> <td><i>n_c</i> - Not Closed</td> </tr> <tr> <td></td> <td><i>n_L</i> - Not Learned</td> </tr> </table>	<i>o^P</i> - Opening	<i>d_c</i> - Closed	<i>d_o</i> - Opened	<i>c_L</i> - Closing	<i>h_o</i> - Hold Open (3-position switch in 'H/O' position)	<i>o_F</i> - Off (3-position switch in 'OFF' position)	<i>n_n</i> - Manual (door(s) was pushed open manually)	<i>n_c</i> - Not Closed	
<i>o^P</i> - Opening	<i>d_c</i> - Closed									
<i>d_o</i> - Opened	<i>c_L</i> - Closing									
<i>h_o</i> - Hold Open (3-position switch in 'H/O' position)	<i>o_F</i> - Off (3-position switch in 'OFF' position)									
<i>n_n</i> - Manual (door(s) was pushed open manually)	<i>n_c</i> - Not Closed									
	<i>n_L</i> - Not Learned									
<i>d^S</i>	Display Sensors – Displays which sensor(s) are in detection:									
	<table border="0"> <tr> <td><i>R_E</i> - Activation Eagle</td> <td><i>S₁</i> - Safety Side Door Mounted 1</td> </tr> <tr> <td><i>R_P</i> - Activation Push Plate/AUX</td> <td><i>S₂</i> - Safety Side Door Mounted 2</td> </tr> <tr> <td><i>R_S</i> - Activation Door Mounted</td> <td><i>S_b</i> - Safety BodyGuard</td> </tr> <tr> <td><i>h_o</i> - Home Switch</td> <td><i>S_P</i> - Safety Photoelectric Beams</td> </tr> <tr> <td></td> <td>-- - None</td> </tr> </table>	<i>R_E</i> - Activation Eagle	<i>S₁</i> - Safety Side Door Mounted 1	<i>R_P</i> - Activation Push Plate/AUX	<i>S₂</i> - Safety Side Door Mounted 2	<i>R_S</i> - Activation Door Mounted	<i>S_b</i> - Safety BodyGuard	<i>h_o</i> - Home Switch	<i>S_P</i> - Safety Photoelectric Beams	
<i>R_E</i> - Activation Eagle	<i>S₁</i> - Safety Side Door Mounted 1									
<i>R_P</i> - Activation Push Plate/AUX	<i>S₂</i> - Safety Side Door Mounted 2									
<i>R_S</i> - Activation Door Mounted	<i>S_b</i> - Safety BodyGuard									
<i>h_o</i> - Home Switch	<i>S_P</i> - Safety Photoelectric Beams									
	-- - None									
<i>d¹</i>	Display Door 1 Position – Displays current position of door 1:									
	<i>00</i> to <i>99</i> - Degrees or “– digit” = 100 to 109 or “– –” = greater than 109, example: – 2 = 102									
<i>d¹¹</i>	Display Door 2 Position – Displays current position of door 2:									
	<i>00</i> to <i>99</i> - Degrees or “– digit” = 100 to 109 or “– –” = greater than 109, example: – 2 = 102 -- - Only one door system									
<i>d⁻</i>	Display Door Mounted 1 Position – Displays learned position of detection of safety side Door Mounted Sensor 1:									
	<i>00</i> to <i>99</i> - Degrees or “– digit” = 100 to 109 or “– –” = greater than 109, example: – 2 = 102 -- - Not learned									
<i>d⁼</i>	Display Door Mounted 2 Position – Displays learned position of detection of safety side Door Mounted Sensor 2:									
	<i>00</i> to <i>99</i> - Degrees or “– digit” = 100 to 109 or “– –” = greater than 109, example: – 2 = 102 -- - Not learned									
<i>d^E</i>	Display Learn Errors – Displays errors generated during door(s) learn: For further explanation of the error codes and corrective actions, please refer to Section 8 - Troubleshooting.									
	<table border="0"> <tr> <td><i>E₁</i> - EDPS 1 baseline too low</td> <td><i>E₅</i> - Door 1 door opened degrees too high (110 maximum)</td> </tr> <tr> <td><i>E₂</i> - EDPS 1 baseline too high</td> <td><i>E₇</i> - Door 2 door opened degrees too low (80 minimum)</td> </tr> <tr> <td><i>E₃</i> - EDPS 2 baseline too low</td> <td><i>E₈</i> - Door 2 door opened degrees too high (110 maximum)</td> </tr> <tr> <td><i>E₄</i> - EDPS 2 baseline too high</td> <td><i>E₉</i> - Safety Side Door Mounted 1 detection degrees too low (65 minimum)</td> </tr> <tr> <td><i>E₅</i> - Door 1 door opened degrees too low (80 minimum)</td> <td><i>E_A</i> - Safety Side Door Mounted 2 detection degrees too low (65 minimum)</td> </tr> </table>	<i>E₁</i> - EDPS 1 baseline too low	<i>E₅</i> - Door 1 door opened degrees too high (110 maximum)	<i>E₂</i> - EDPS 1 baseline too high	<i>E₇</i> - Door 2 door opened degrees too low (80 minimum)	<i>E₃</i> - EDPS 2 baseline too low	<i>E₈</i> - Door 2 door opened degrees too high (110 maximum)	<i>E₄</i> - EDPS 2 baseline too high	<i>E₉</i> - Safety Side Door Mounted 1 detection degrees too low (65 minimum)	<i>E₅</i> - Door 1 door opened degrees too low (80 minimum)
<i>E₁</i> - EDPS 1 baseline too low	<i>E₅</i> - Door 1 door opened degrees too high (110 maximum)									
<i>E₂</i> - EDPS 1 baseline too high	<i>E₇</i> - Door 2 door opened degrees too low (80 minimum)									
<i>E₃</i> - EDPS 2 baseline too low	<i>E₈</i> - Door 2 door opened degrees too high (110 maximum)									
<i>E₄</i> - EDPS 2 baseline too high	<i>E₉</i> - Safety Side Door Mounted 1 detection degrees too low (65 minimum)									
<i>E₅</i> - Door 1 door opened degrees too low (80 minimum)	<i>E_A</i> - Safety Side Door Mounted 2 detection degrees too low (65 minimum)									

NOTE: Remember when troubleshooting, these displays can be extremely helpful in quickly identifying possible error conditions.

NOTE: Make sure the display shows *d^P* before completing all work.

7 Documentation

- Document all work. For future reference, be sure to record the DP-Hub serial number on your work order. It is also a good idea to record all function settings (on your work ticket) that were programmed into the DP-Hub.
- Be sure to obtain signatures on your work order for all work accomplished.

8 Troubleshooting

If the DP-Hub is powered on and acting erratically, the best solution is to first use the 'Operating Parameters' in conjunction with the 'Programming Parameters' as described in Section 6 - Programming the DP-Hub for troubleshooting. The information obtained can also be used with the six LEDs on the DP-Hub. The description of the LEDs is shown below. Once the problem is determined the corrective actions can be taken as specified by the second table. Finally if you cannot solve the problem on your own, you can contact BEA Technical Support whose contact information is provided in Section 9.

LED	DESCRIPTION
Green	DP-Hub activation relay is active
Yellow	DP-Hub stall relay is active
Red	DP-Hub safety relay is active
Orange	DP-Hub home switch is active (contact is closed)
Blue	DP-Hub is in Learn mode
White	EDPS baseline is being tracked

NOTE: If the display goes blank but you have HOME, LEARN and TRACKING, the DP-Hub is relearning the sensor baseline for approximately one second - this is normal.

NOTE: When troubleshooting with error codes, the lower error code number is a higher priority error. Fixing the lowest error code number first may resolve subsequent errors.

PROBLEM	PROBABLE CAUSE	CORRECTIVE ACTION
DP-Hub is not showing any display	No input power	Check input power as it must be 12 to 24 VAC/VDC: +/- 10%, do not power from the door control
	Faulty DP-Hub	Replace DP-Hub
Door will not open or close	Door control issue	Remove the DP-Hub from the door control by unplugging the Door Control Harness(es). Attempt to open the door via the door control. If door does NOT open, troubleshoot door control
	No inputs or outputs connected	Connect (as a minimum) the ON/OFF/HOLD Switch in the ON position, the BodyGuard, the EDPS(s), an activation device and door control
	BodyGuard data and/or relay configuration and/or pattern width is incorrect	Verify BodyGuard relay configuration, BodyGuard data type matches DP-Hub and pattern width is set correctly
	DP-Hub function <i>FR</i> set to 01 when no AUX is used	Check function <i>FR</i> at the hub. If no AUX device is used, value should be set to 00
	Safety Beam input <i>Fb</i> is set incorrectly	Check function <i>Fb</i> at the hub. If no SBK-30 beams are plugged into the hub, value should be set to 00
	SBK-30 Beams misaligned	Align SBK-30 Beams
	SBK-30 Beams faulty	Replace SBK-30 Beams
	Door Mounted Sensor wiring is incorrect	Check wiring of Door Mounted Sensors (Section 5-6)
Door keeps recycling open (ghosting).	Activation sensor 'seeing' the door movement.	Adjust motion sensor or door mounted sensor at non-safety side.
BodyGuard flashing orange	Bodyguard data is incorrect	Check and change <i>F1</i> at BodyGuard if needed
		Check and change <i>FL</i> at DP-Hub if needed
		Check wiring of BodyGuard (Section 5-4)
Error codes <i>E1</i> & <i>E3</i>	EDPS is not connected to DP-Hub	Check wiring of EDPS (Section 5-7)
	EDPS is configured for 2 doors but is installed on a 1 door system	Check function <i>Fd</i> at the hub. If it only a 1 door system, value should be set to 01
	Faulty EDPS	Replace EDPS
	Faulty DP-Hub	Replace DP-Hub
Error codes <i>E2</i> & <i>E4</i>	EDPS is not connected correctly to DP-Hub	Check wiring of EDPS (Section 5-7)
	Faulty EDPS	Replace EDPS
	Faulty DP-Hub	Replace DP-Hub

8 Troubleshooting (continued)

PROBLEM	PROBABLE CAUSE	CORRECTIVE ACTION
Error codes E5 & E7	Door did not make it fully opened	Check and change F_h at DP-Hub if needed to make the door reach full open or adjust door so that it opens at least 80 degrees
	Bad learn	Perform a new DP-Hub learn
	Home Switch is breaking too late, or is wired incorrectly, or is faulty	Check Home Switch (Section 5-8)
	Faulty EDPS	Replace EDPS
	Faulty DP-Hub	Replace DP-Hub
Error codes E5 & E8	Door opened too far	Adjust door so that it opens less than 110 degrees
	Bad learn	Perform a new DP-Hub learn
	Faulty EDPS	Replace EDPS
	Faulty DP-Hub	Replace DP-Hub
Error codes E9 & E8	Door Mounted Sensor going into detection too soon	Check the Door Mounted Positions using the Operating Parameter and if the degree is greater than 0 but less than 65, adjust the sensor by angling it in closer to the door or raise the detection threshold from the floor
	Door Mounted Sensor wiring is incorrect	Check the Door Mounted Positions using the Operating Parameter and if the degree is 0, check wiring of Door Mounted Sensors

9 ANSI / AAADM Compliance

- Upon finishing of the installation perform at a minimum a daily safety check in accordance with the minimum inspection guidelines provided by AAADM, provide each owner with an owner's manual that includes a daily safety checklist and contains at a minimum the information recommended by AAADM, and offer a familiarization session with the owner explaining how to do daily inspections and calling out location of cutoff switches to put equipment out of service if a deficiency is noted. The equipment should be inspected in accordance with the minimum inspection guidelines annually. A safety check that includes at a minimum the items listed on the safety information label must be performed during each service call. If you are not an AAADM certified inspector BEA strongly recommends to have an AAADM certified inspector perform an AAADM inspection and placing a valid inspection sticker below the safety information label prior to placing the equipment into operation.

10 Company Contact

24/7 Technical Support:
1-800-407-4545

Customer Service:
1-800-523-2462

General Technical Questions:
Tech_Services@beainc.com

Technical Documentation:
www.beasensors.com

Appendix A - Wiring Diagram

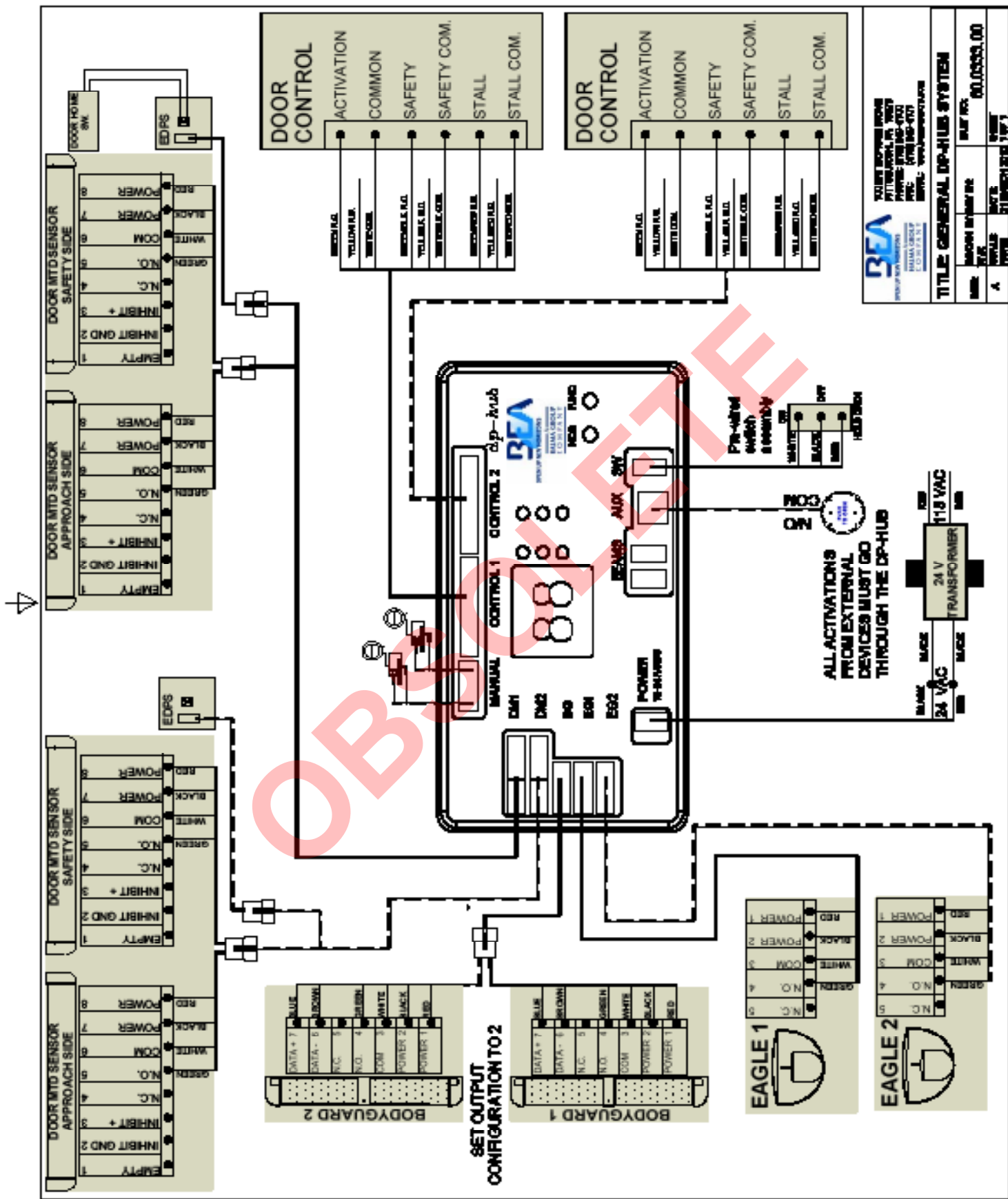

BEA
BELL & HOWELL ASSOCIATES
CORPORATION
10050 WILLOW CREEK DRIVE
DALLAS, TEXAS 75243-2255
TEL: 214-342-0000
FAX: 214-342-0001

BEA
BELL & HOWELL ASSOCIATES
CORPORATION
10050 WILLOW CREEK DRIVE
DALLAS, TEXAS 75243-2255
TEL: 214-342-0000
FAX: 214-342-0001

TITLE: GENERAL DP-HUB SYSTEM

DATE	REV	DESCRIPTION	BY
01/01/00	1	ISSUE FOR CONSTRUCTION	...

BLUF NO: 00.03593.00

Appendix B - Door Controls

DP-Hub Wire Color	Green	Yellow	White	Green/ Black	Yellow/ Black	White/ Black	Green/ Red	Yellow/ Red	White/ Red
Door Control	ACT NO	ACT NC	ACT COM	SAFE NO	SAFE NC	SAFE COM	STALL NO	STALL NC	STALL COM
Besam 300 / ETIK	13		12	11		12	N/A	15	16
Besam MP/CUP	3		4	9		4	5		4
Besam SM900/CU2	TB-1		TB-3	TB-2		TB-3	TB-7		TB-3
Door O Matic	Yellow		Grey	Blue		Grey	Purple		Grey
Dorma 400/700	TRIG		GND	PRES		GND	SWING		GND
Gyrotech 300/400	Black		Red	White		Red	White		Red
Gyrotech MAG	6 Black		5 Red	4 White		5 Red	3 Violet		5 Red
Horton 4190	2		3	4		3	10		3
Hunter	ACT		RTN	SAF 1		RTN	SAF 2		RTN
Keane Monroe K	Green		White	Red		White	Yellow		White
Record 6000/8000 ¹	2		1	8		4	N/A	10	11
Stanley L	Orange		Yellow	Red		Yellow	Blue		Yellow
Stanley MP	2		8	7		8	7		8
Stanley 521 ²	TB4-4		TB4-3	TB3-8		TB3-7	TB3-4		TB3-3

1. Terminals 11 and 12 must be jumped.

2. If removing Stanley on/off/hold open switch and replacing with BEA version, terminals TB2 2 and 3 must be jumped and if there is no breakout, terminals TB3 9 and 10 must be jumped.

NOTE: If your door control is not shown above please refer to appropriate installation manual as this system will work on any door.

Appendix C - Home Switch

1 Retro Fit or Precision Install

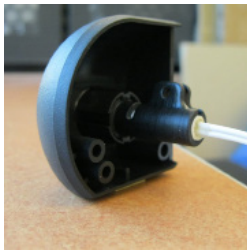

Home Switch Default

Home Switch Extended

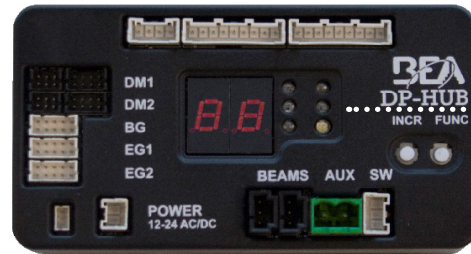
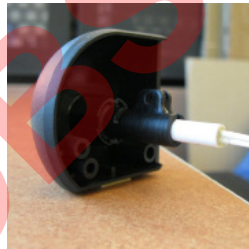

Home Switch LED (orange)

In some cases it may be necessary to adjust the Home Switch for a retro fit application where the Door Mounted Sensor Extrusions were previously installed and are not close to the ideal mounting location of approximately 1" apart, or if you just want to make the install as precise as possible.

If the extrusions are too close, the Home Switch will open too late and it's possible that the BodyGuard may still see the door(s) on a manual push or stack pressure before the switch opens, thus causing safety. Conversely if the extrusions are too far apart, the Home Switch may not close at door closed.

To precisely adjust the Home Switch you have two options. First you can use the Home Switch LED (orange) on the DP-Hub. To use the Home Switch LED the DP-Hub must be powered, the magnetic reed switch must be wired into the EDPS and the EDPS must be plugged into the DP-Hub. Alternatively if you have a multimeter with continuity, all you will need to do is remove the magnetic reed switch wires from the EDPS and connect them to your meter with it set to continuity.

- Loosen the set screw from the Home Switch collar and pull out or push in the magnetic reed switch in the collar so that it corrects your Home Switch problem. If the extrusions are less than 1" apart, you will need to pull out the magnetic reed switch from the collar. Conversely if you the extrusions are greater than 1" you will have to push in the magnetic reed switch into the collar. Note that the absolute maximum range of the magnetic reed switch is 1 1/2", thus if you are further than that apart you will have to re-install the extrusions or select an alternative solution as described in the next section.
- Check the Home Switch precision using either the Home Switch LED or your meter. You want the switch to be closed when the door(s) is closed, but you want to switch to open within a few degrees when the door(s) are off of your desired home. Repeat until your desired location is found. A simple way to perform this with the meter is to pull the switch out until you lose continuity, the push it back in slightly.
- Tighten the set screw on the Home Switch collar and jump back to the previous installation step.

Appendix C - Home Switch (continued)

2 Alternative Solutions

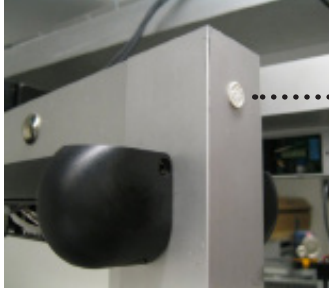

Magnetic bullet switch in the nose of the door

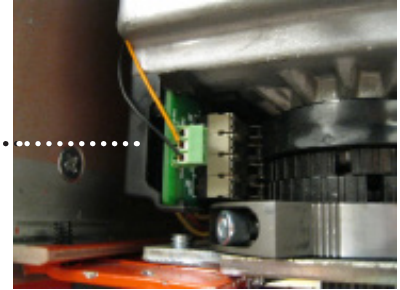

Mechanical limit switch on operator

If you cannot use the **typical** installation, perhaps due to vertical rods or the customer does not like the look of the Surface Mount Adapter, there are several alternatives. All you simply need is to connect a DRY contact switch that is **closed when the door is closed**.

For example you could use a magnetic bullet switch in the nose of the door with the magnet in the jamb or the other door. Here you could drill a hole through the extrusion and frame and route the wires into the extrusion, then into the EDPS.

Another example would be to use the mechanical limit switch(es) on an equipped operator. You could install separate wires and route them through the door to the EDPS or you could simply splice into the 8-pin connector on one of the EDPS harnesses at the DP-Hub at the orange (pin 3) and orange/black (pin 4) wires. Note that if using the limit switches on a pair of doors, the switches would need to be wired in series.

Those are only a **few** examples as the possibilities are endless.

NOTE: You only need to connect the alternative solution into **one** EDPS or **one** EDPS harness.