

1 Description

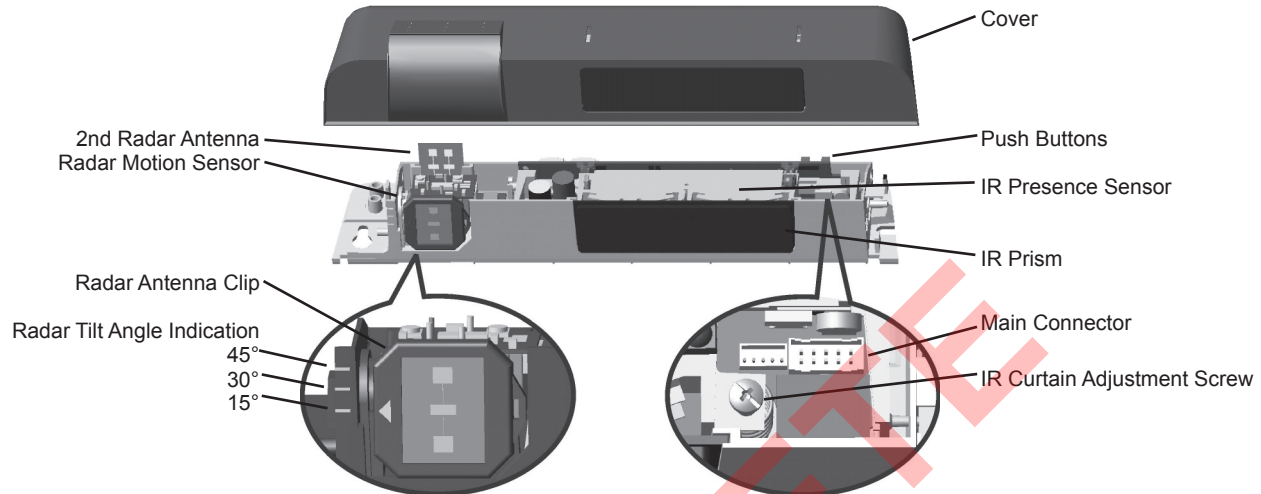

2 Specifications

DESCRIPTION	SPECIFICATION
Supply voltage	12 to 24 VAC / VDC: -5% to +10%
Power frequency	50 / 60 Hz
Power consumption	< 3 W
Mounting height	5'9" to 8'2" 8'2" to 13'0"
• Standard • High	
G3 data input	10 to 30 VDC
Delay of the output activation after stimulation	Transistor : < 1ms
3-color LED	<ul style="list-style-type: none"> • RED: presence detection • GREEN: motion detection • ORANGE: monitoring process
Temperature range	-30°F to +131°F
Degree of protection	NEMA 3S / (IP54)
Product conformity	R&TTE 1999/5/EC & EMC 89/336/EEC BZT Germany, TÜV
Dimensions	10.4" x 2.2" x 1.9"
Weight	.55 lbs / 250 g
Housing material	ABS & LURAN S
Color of Housing	Anthracite gray (standard), aluminum, dark bronze, black or white finish
Cable length	10' of 6-conductor cable

DESCRIPTION	MOTION SENSOR	PRESENCE SENSOR
Technology	Microwave and microprocessor Transmitter frequency: 24.125 GHz Transmitter radiated power: <20 dBm EIRP Transmitter power density: < 5 mW/cm ²	Focused active infrared and Self-monitored microprocessor Spot diameter (standard): 4" max Number of spots: 24 or 12 spots by curtain Number of curtains: 2
Detection field (standard)	13'0" W x 6'6" D 6'6" W x 8'2" D	6'6" W x 13.75" D 3'3" W x 13.75" D
• Wide field • Narrow field		

2 Specifications (Continued)

DESCRIPTION	MOTION SENSOR	PRESENCE SENSOR
Detection mode	Minimum detection speed 2 inches / sec. (measured in the sensor axis)	Response time: < 128ms
Angle	From 15° to 50° in elevation (adjustable)	From - 4° to + 4° (adjustable)
Output specification	Relay (free of potential change-over contact): • Max contact voltage: 42V AC/DC • Max contact current: 1A (resistive) • Max switching power: 30W (DC) / 60VA (AC)	Transistor (optocoupled transistor) • Max output current: 100 mA • Max switching power: 48 VDC
Output hold-time	0.5s to 9s (adjustable)	1s (fixed)
Manual adjustment	• orientation of sensing field (mechanically) • shape of the sensing field (choice of antenna) • multiple functions (using push buttons)	• orientation of sensing field • shape of the sensing field (choice of front lens) • multiple functions (by push buttons)
Remote control adjustments	• Sensitivity • Hold time • Detection mode • Immunity • Output configuration	• Immunity • Auto-learn time • Monitoring mode • Number of Curtains • Relay / Output configuration

3 Precautions



CAUTION

- Shut off all power before attempting any wiring procedures.
- Maintain a clean & safe environment when working in public areas.
- Constantly be aware of pedestrian traffic around the door area.
- Always stop pedestrian traffic through the doorway when performing tests that may result in unexpected reactions by the door.
- ESD electrostatic discharge: Circuit boards are vulnerable to damage by electrostatic discharge. Before handling any board ensure you dissipate your body's charge.
- Always check placement of all wiring before powering up to insure that moving door parts will not catch any wires and cause damage to equipment.
- Ensure compliance with all applicable safety standards (i.e. ANSI A156.10 / 19) upon completion of installation.
- DO NOT attempt any internal repair of the sensor. All repairs and/or component replacements must be performed by BEA, Inc. Unauthorized disassembly or repair:
 1. May jeopardize personal safety and may expose one to the risk of electrical shock.
 2. May adversely affect the safe and reliable performance of the product will result in a voided product warranty.

4 Pre Installation Check

1. When preparing to wire multiple devices together for a 'System' configuration, it is best to ensure the correct operation of each device independently before starting to help reduce troubleshooting time later in the event of a discrepancy.
2. Prior to installing any equipment, ensure the correct line voltage and stability. When applying equipment on a new installation utilizing new electrical supply circuits, always ensure that correct line voltage exists and is stable. Remember to shut the power back off after this is checked and before performing any wiring to the system.

5 Installation

1 Remove Sensor Cover

1. Remove cover from unit by gently prying the tab on the backside of the sensor housing or if the sensor is installed on the header insert a screwdriver behind the unit and gently pry off the cover.

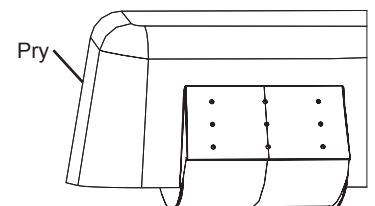
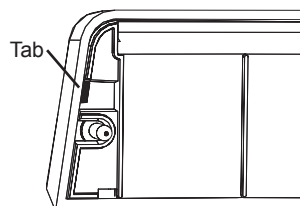

5 Installation (Continued)

2 Mount Sensor

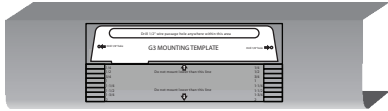

- Using scale on template, position drawing of sensor on template 0" to 2" from bottom of header.

NOTE: Flush mount with bottom of header is necessary for all negative IR angles.



- Drill hole marked for wire passage and drill pilot holes for screw mounting. Remove template prior to sensor installation.

- Insert mounting screws approximately halfway in and install the G3 on the screws. When in place, tighten screws to secure to header.

NOTE: Leave cover off until mechanical adjustments are complete.

3 Cable Routing

- With G3 in place, locate the enclosed cable and feed the stripped end through the wire passage hole in the header.
- Leave enough slack to allow connection to the G3 and proper routing of wire around the plastic post.

NOTE: Observe proper routing of the cable as shown. This is to divert rainwater from the G3 if water should run down the cable. Proper routing of the wire also provides easier installation of the cover.

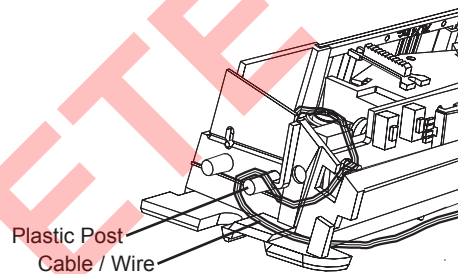

4 Sensor Wiring

- When connecting to a microprocessed control box, the motion output and presence output wires may be connected to separate inputs or may also be connected to a mutual input. Some controls may only have an activation input, while others may have an activation input, as well as a safety (or presence) input.

Wiring the G3 to an Automatic Door Control with Separate Activation and Safety Inputs

O P T I O N 1	Color	Microprocessed Controls
	Red	12 to 24 VAC / VDC: -5% to +10%
	Black	12 to 24 VAC / VDC: -5% to +10%
	White	Common at Door Control
	Green	Activation Input at Door Control
	Brown	Common at Door Control
	Blue	Safety Input at Door Control

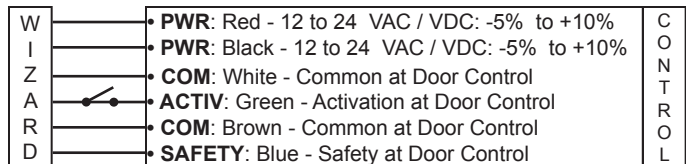

For Secondary Activation see important note on page 6.
For One Way Evening Mode see addendum 5 on page 15.

Wiring the G3 to an Automatic Door Control with Activation and Safety Wired to One Input

O P T I O N 2	Color	Controls Without Safety Circuit
	Red	12 to 24 VAC / VDC: -5% to +10%
	Black	12 to 24 VAC / VDC: -5% to +10%
	White	Common at Door Control
	Green	Activation Input at Door Control
	Brown	Common at Door Control
	Blue	Activation Input at Door Control

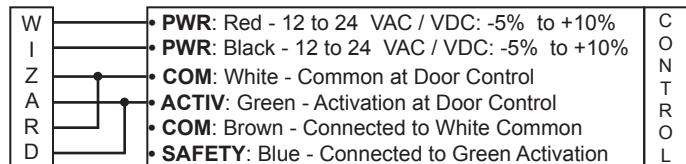

Brown and Blue may be connected to White and Green

Wiring the G3 to an Automatic Door Control with Activation and Safety Signal through Relay Only

O P T I O N 3	Color	Controls Without Safety Circuit
	Red	12 to 24 VAC / VDC: -5% to +10%
	Black	12 to 24 VAC / VDC: -5% to +10%
	White	Common at Door Control
	Green	Activation Input at Door Control
	Brown	Not Used
	Blue	Not Used

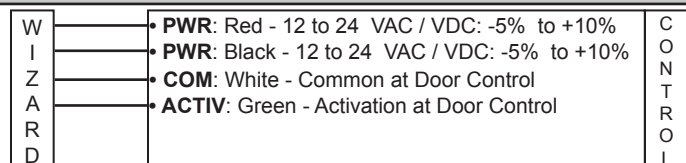

White and Green provide output for motion and presence detection

On Remote Control Set: **F1** To **1**

6 Mechanical Adjustments

1 Radar Motion Sensing Field: Width

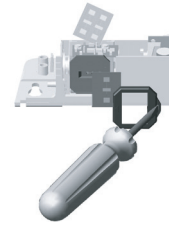
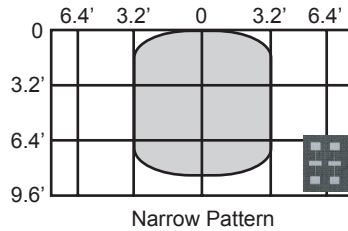
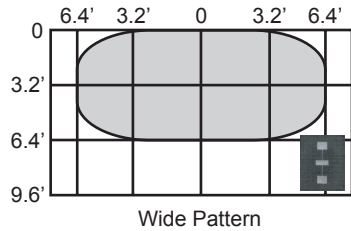

1. Insert the desired microwave antenna for a wide or narrow field of detection. The optional narrow field antenna is located in the slot behind the mounted antenna as shown. To remove the antenna, carefully remove the protective cover and change the antenna. Once the proper antenna is in place, adjust the angle of antenna as necessary.

2 Radar Motion Sensing Field: Depth

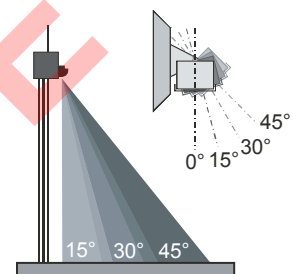
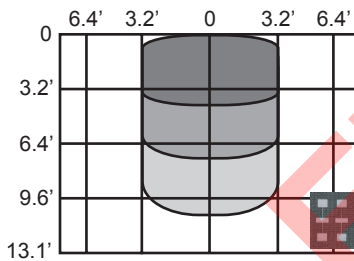
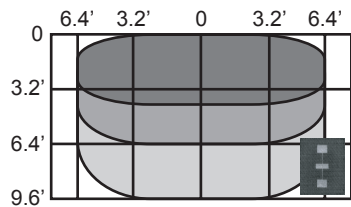

1. The position of the sensing field is determined by the vertical angle of the planar antenna. The angle is adjusted by gently rotating the antenna forward or backward. The default angle is 30°.
2. The tilt angle is determined by the position of the sensor with relation to the face of the door. A 45° angle will place the pattern further away from the door. Be certain to walk test the detection field and ensure compliance with applicable ANSI standards.

3 IR Presence Sensing Field: Width

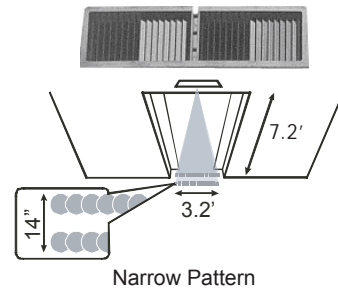
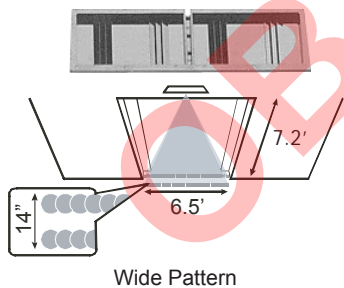

1. Install the lens for the desired IR pattern. The wide pattern offers 2 curtains of 24 overlapping spots and the narrow pattern offers 2 curtains of 12 overlapping spots. When installing the lens ensure the smooth part of the lens is installed facing outward.

4 IR Presence Sensing Field: Depth

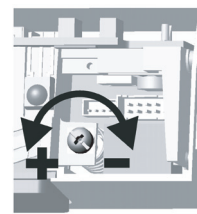
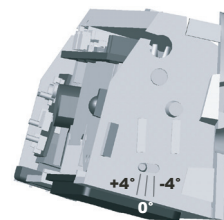
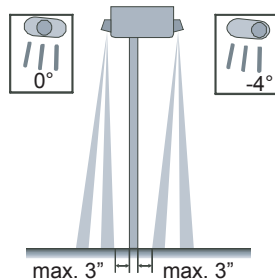

Sensor Plastic Pin Indicator

Sensor Adjustment Screw

1. The IR pattern may be adjusted by moving the pattern nearer or further away from the face of the door by adjusting the tilt angle from +4° to -4°. A counterclockwise rotation of the adjustment screw will move the curtain further away from the door and clockwise rotation will move the curtain toward the door. Precise location of the IR beam may be found by using BEAs Spotfinder P/N 10SPOT.

7 Remote Control Adjustments

1 Important Remote Control Adjustments

Every programming session begins by unlocking the sensor. Thereafter a program setting may be altered by pressing the desired function key followed by the desired value for that function. When all programming is complete press the lock key twice to retain settings. Use the following as a guide:

Unlock the sensor to enter into adjustment session (if no access code has been entered)	Press Unlock Key	RED LED Flashes Slowly			
To change the value of a parameter (ex. Maximum duration of presence detection)	Select Parameter to Change	RED LED Flashes Quickly	Enter New Value	RED LED Flashes Slowly	
... to change any other parameters (ex. Output Configuration)	Select Parameter to Change	RED LED Flashes Quickly	Enter New Value	RED LED Flashes Slowly	
To check the value of a parameter (ex. maximum duration of presence detection)	Select Parameter to Check	RED LED Flashes Quickly	Press Question Mark	The Number of Green Flashes Indicate the Value of This Parameter	RED LED Flashes Slowly
Lock the adjustment session and go back to normal function	Press Lock Key Twice	OR	+ Lock Code		

Safety Output Redirection F1

0: No Redirection

- 1: Transfer Presence Detection To Activation Output (All Relay Output)
- 2: Activation Output Only Upon Motion and Presence Detection
- 3: N/A - Future
- 4: N/A - Future

Unlock

Check Value

Lock

Relay Hold Time

0 (0.5s) → 9 (9s)

Sensitivity

0 (min) → 9 (max) **default = 7**

Microwave Detection Mode

- 1: Bidirectional Mode
- 2: Unidirectional Mode
- 3: Unidirectional Mode with MTF

Radar Motion Detection

IR Presence Detection

Installation Configuration

	Mounting Height	Pulse Frequency
Single Unit		
1	Low	Low
2	High	Low
3	Low	High
4	High	High
Overlapping Units		
5	Low	Low
6	High	Low
7	Low	High
8	High	High

See Important Notes Page 6

Door Control F2

- 1: Normal (LED in Normal Mode)
- 2: Door Permanently Open (Red LED On)
- 3: Door Permanently Closed (Red LED Off)

Microwave Immunity

- 1: Reduced
- 2: Normal
- 3: Increased
- 4: through 9: Higher number equals higher immunity level.

See Important Notes Page 6

7 Remote Control Adjustments (Continued)

2 Important Remote Control Adjustments

Important Notes

- Defaults are Shown in Bold Print
- Restore Factory Defaults
Magic Wand + 9
Sensor will Self Launch Set Up
- Quick Set Up has Two Second Duration
- Assisted Set Up is recommended for first time set up. Duration is 16 seconds and will automatically trigger door to open position during set up routine.

Microwave Immunity: Immunity levels above 3 are intended for applications where excessive interference may be causing unintended detection. When applying a value of 4 or higher increment the value one step at a time followed by a walk test. When complete, ensure compliance with all applicable safety and performance standards.

Secondary Activation: On a one-way traffic application, use a toggle switch or other switch to break the green wire to door control. Door control safety circuit must turn off in door closed position.

Installation Configuration: To prevent crosstalk when installing overlapping units set one unit to 5 and one unit to 7 for Low mount or one unit to 6 and one unit to 8 for High mount.

Reset access code to default: Power cycle the sensor and within 60 sec. press unlock, lock, 0000.

Infrared Immunity

- 1: Normal**
 - 2: High (extreme snow, rain, pedimats or lighting)
- See Important Notes

- Radar Motion Detection
- IR Presence Detection

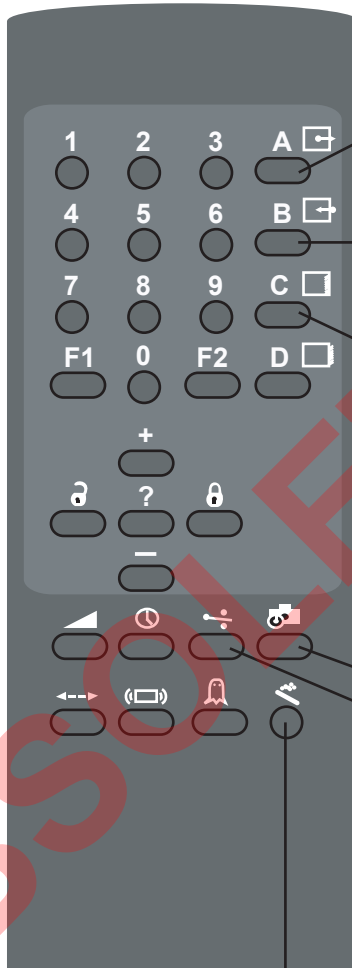

External Monitoring SMR

0: **Monitoring Disabled (Off)**
SMR (Off)

1: Monitoring Enabled (On)
SMR (On)

Number of IR Curtains

1: 1 Curtain
(Safety Curtain Close to the Door)

2: 2 Curtains

3: **2nd Curtain in Dynamic Mode**
(Enabled After a Motion Detection)

Secondary Activation Sensitivity

0 (min) → 9 (max) **default = 0**

Automatic Learn Time

0: 30 Seconds	4: 10 Minutes
1: 1 Minute	5: 20 Minutes
2: 2 Minutes	6: 60 Minutes
3: 5 Minutes	9: Infinity No Learn

Output Configuration

	Motion Out	Presence Out
1	Active / N.O.	Passive / N.C.
2	Passive / N.C.	Active / N.O.
3	Passive / N.C.	Passive / N.C.
4	Active / N.O.	Active / N.O.

Setup

	Launch Quick Setup
	Launch Assisted Setup
	Restore Factory Settings <i>Note:</i> F1 function and the access code are not reset.

3 Launch Set Up of Infrared Curtains

Unlock the sensor to enter into adjustment session	Press Unlock Key	RED LED Flashes Slowly	
To Launch an Assisted Set Up → Required after mechanical adjustments of the IR sensor module → Required once after first installation	Press Set Up	Press 0	RED / GREEN LED Alternating Flashes
			The sensor performs a door opening and closing cycle to check the influence of the door leaves to the safety curtains. See Troubleshooting if RED LED flashes quickly after set up.

8 Manual Set Up Without Remote

1 Manual Set Up

Set up of the G3 may be accomplished by the use of two G3 mounted programming buttons. The procedures below indicate how to program using these buttons.

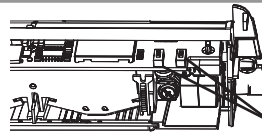

Program Buttons

NOTE: Red LED indicates parameter. Green LED indicates value.

To begin programming:	Briefly press the right button and move away from the sensing zones.
To reset the unit to factory defaults:	Press and hold both buttons simultaneously until both Red and Green LEDs flash alternately. NOTE: F1 function and the access code are not reset after pressing the manual program buttons.
To customize the settings from factory defaults:	To enter the customizing mode: Press the right button until the LED flashes and then release. To return to standard mode: Press the right button again until the LED stops flashing and then release.
Customizing Mode:	<ul style="list-style-type: none"> • The Red LED light indicates the number for the parameter being altered (1 flash = parameter #1). • The Green LED light indicates the value for the parameter being altered (1 flash means value = 1). • The Right Button enables selection of the parameter number being altered (+1 for each press). • The Left Button enables alteration of the parameter (+1 for each press).
Helpful Hint:	When the sensor is wired correctly pressing and holding the left button will result in disconnecting all outputs from that sensor, allowing the door to close, if no other devices are being activated.

PARAMETER NUMBER (Altered by the right button and confirmed by RED LED)	PARAMETER	VALUES (Altered by the left button and confirmed by GREEN LED)	DEFAULT VALUE
1	Radar Sensitivity	0 - 9	7
2	Relay hold time	0 - 9	0
3	Output configuration	1 - 4	4
4	Auto-learn presence sensing	0 - 9	0
5	Detection mode	1 - 4	3
6	Microwave Immunity	1 - 9	3
7	IR Immunity	1 - 3	1
8	Not Used	Displays 8 Orange Flashes	Displays 8 Orange Flashes
9	Not Used	0	0
10	IR curtain	1 - 3	3
11	Secondary Sensitivity	0 - 9	0
12	Height & Frequency	1 - 4	1
13	Output Re-Direction	0 - 4	0
14	Door Control Function	1 - 3	1
15	Not Used	Displays 15 Orange Flashes	Displays 15 Orange Flashes

<p>EXAMPLE: Change radar sensitivity from 7 to 9 and set hold time to 4 seconds:</p> <p>NOTE: When the highest value for the parameter has been reached, the value will "roll over" to its lowest value (e.g. for radar mode: 1, 2, 3, then 1, 2, ...). The sensor automatically returns to standard mode if neither button has been pressed for one minute.</p> <p>REQUIRED: If the IR frequency has been manually changed, to prevent the sensors from being in permanent detection, momentarily depress the right program button to launch an assisted setup.</p>	<p>Press the right button for 2 seconds, you will enter the customizing mode:</p> <ul style="list-style-type: none"> • The red LED flashes once (parameter 1) • The green LED flashes 7 times (sensitivity = 7) • Press the left button twice to move from sensitivity = 7 to sensitivity = 9 <p>Press the right button once to move to Parameter 2 (relay hold time):</p> <ul style="list-style-type: none"> • The red LED flashes twice (parameter 2) • The green LED does not flash (hold time = 0 seconds) • Press the left button four times to move from hold time = 0 to hold time = 4 seconds
---	---

9 Power Up

1 Power Up Procedures

STEP	USER'S ACTION	RESULT
Step 1	With all wiring in place, apply power to door control and 12 to 24 VAC / VDC: -5% to +10% to G3. Once powered, observe LED status on the G3. Stop all traffic through the doorway while performing this step, and remain clear of the G3's detection zones.	The G3 will show a steady red LED during the set-up procedure. Once the G3 completes setup, the door will close and begin normal operation thereafter. Setup process takes approximately 6 seconds, if uninterrupted.
Step 2	If the sensor is being powered for the first time, because of new installation or sensor is being replaced, unlock the G3 and Press the Magic Wand Key, followed by a number 0. Observe the LED status during setup. Once set-up is complete, the LED indication will reflect the status of the set-up. Observe the LED while standing outside of the detection zones.	<ul style="list-style-type: none"> • NO LED UPON COMPLETION = Successful setup • RED LED ON = Presence being detected -G3 is seeing an object. • GREEN LED MOMENTARILY ON = MOTION DETECTION (G3 sees movement). Adjust microwave functions: angle, sensitivity, immunity. • ORANGE LED ON = Possible fault. If LED stays on, reset power and observe LED. If it comes back on steady, replace G3. • Fast flashing Red = setup failed due to improper IR curtain adjustment or disturbance of IR curtain during setup.
Step 3	Proceed with fine tuning the mechanical , as well as the program adjustments of the G3. Refer to the applicable sections of this manual for altering any settings. Be sure to check: <ul style="list-style-type: none"> • Motion width & depth • Presence width & depth • Position of infrared curtain • Sensitivity of motion field 	Sensor must always be adjusted to be in compliance with the current version of ANSI A156.10.

10 Troubleshooting

1 Troubleshooting Procedures

PROBLEM	PROBABLE CAUSE	CORRECTIVE ACTION
Orange LED is illuminated on G3.	<ol style="list-style-type: none"> 1. G3 IR is in saturation 2. Internal fault within the G3 3. Faulty Power Input 	<ol style="list-style-type: none"> 1. Launch a new setup and remain all clear from the detection area. 2. Remove power, then re-apply. Input power may have fluctuated beyond tolerances.
Red LED flashes after attempting a set-up.	<ol style="list-style-type: none"> 1. Infrared curtains are too close to the door and the sensor detects a door influence. 2. IR curtain too far away from door. 3. IR curtain disturbed during setup. 	<ol style="list-style-type: none"> 1. Adjust Infrared curtain as necessary. Use of BEA's Spotfinder during this process is recommended. 2. Adjust Infrared curtain as necessary. Use of BEA's Spotfinder during this process is recommended. 3. Relaunch a setup and keep people away from door until setup completes.
Door will not close Red LED off at G3.	<ol style="list-style-type: none"> 1. On-Off switch at door control in wrong position or is faulty. 2. Improper Relay Configuration on G3. 3. Faulty door control. 	<ol style="list-style-type: none"> 1. Check to insure On-Off switch for door is in the ON or AUTOMATIC position. If switch is in correct position, check switch with multi-meter for proper operation. 2. Insure correct polarity at Brown and Blue wires 3. Check Relay Configuration setting on each G3. Refer to page 6 for settings. 4. Remove all sensor inputs from the door control. If door remains open, fault exists with door control or motor. Refer to manufacturer's manual for further troubleshooting. If door closes with sensor inputs removed, fault exists with sensors or related wiring.

10 Troubleshooting (Continued)

1 Troubleshooting Procedures

PROBLEM	PROBABLE CAUSE	CORRECTIVE ACTION
Door opens when it should close.	1. Relay Configuration on wrong setting.	1. Check Relay Configuration setting.
Door will not open.	1. On-Off switch at door control in wrong position or is faulty.	1. Check to insure On-Off switch for door is in ON or AUTOMATIC position. If it is in correct position, check switch with multi-meter for proper operation.
Door will not open (Continued).	1. G3 not detecting traffic. 2. Faulty wiring between sensor and door control. 3. Faulty door control.	1. Walk in and out of G3 detection area, if green LED does not illuminate check: a. Power supply for G3: 12 to 24 VAC / VDC: -5% to +10% b. Check G3 setting on each G3. c. Check Relay Configuration for each G3. 2. Remove all sensor inputs from the door control. Jumper the common and activate terminals of the door control. If door does not open, fault lies within door control or motor. Refer to manufacturer's manual for further troubleshooting. If door opens, fault lies with sensors or related wiring. 3. Refer to Step 2.
Door keeps recycling open.	1. G3 is seeing door. 2. G3 is seeing movement from unwanted objects. 3. Vibration is triggering the G3.	1. Observe LED status on each G3. Green LED indicates motion detection, red LED indicates presence. If LED's are on, make sensor adjustments as necessary to eliminate unwanted detection. Check angle, sensitivity, and immunity for presence and motion. 2. Check for moving objects in the path of detection, such as posters, banners, etc. 3. Locate source of vibration and correct as necessary.
G3 will not respond to remote control.	1. Batteries in remote are dead or are installed improperly.	1. Ensure batteries are installed correctly. Replace batteries: AAA 1.5 volt.
G3 will not unlock when access code is entered.	1. Improper code being entered.	1. Reset code to the default value of 0000 by performing the following: a. Cut and restore power supply. No code is required to unlock during the first minute after powering. Reset code prior to locking.

11 ANSI / AAADM Compliance



Upon finishing the installation and/or service work perform at a minimum a daily safety check in accordance with the minimum inspection guidelines provided by AAADM. Provide each owner with an owner's manual that includes a daily safety checklist and contains at a minimum the information recommended by AAADM. Offer a familiarization session with the owner explaining how to do daily inspections and calling out location of cutoff switches to put equipment out of service if a deficiency is noted. The equipment should be inspected in accordance with the minimum inspection guidelines annually. A safety check that includes at a minimum the items listed on the safety information label must be performed during each service call. If you are not an AAADM certified inspector BEA strongly recommends to have an AAADM certified inspector perform an AAADM inspection and placing a valid inspection sticker below the safety information label prior to placing the equipment into operation.

12 Accessories

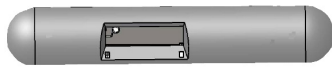

Ceiling Adapter
10WCA



Universal Rain Cover
10URC



Weather / Rain Cover
10WRC



Spotfinder
10SPOT

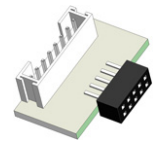

Cable Adapter
10IFBWIZARDII

13 Company Contact



OPEN UP NEW HORIZONS
A HALMA COMPANY

Do not leave problems unresolved. If a satisfactory solution cannot be achieved after troubleshooting a problem, please call BEA, Inc. If you must wait for the following workday to call BEA, leave the door inoperable until satisfactory repairs can be made. Never sacrifice the safe operation of the automatic door or gate for an incomplete solution.

Our Service Technicians can be called 24 hours a day, 7 days a week. For more information visit www.beasensors.com.

Phone: 1-800-523-2462		Fax: 1-888-523-2462	
After Normal Business Hours			
West / Mexico 1-888-419-2564	Central 1-800-407-4545	AK, MI, WI, TX, Canada 1-866-836-1863	East 1-866-249-7937

OBSOLETE

Addendum 1

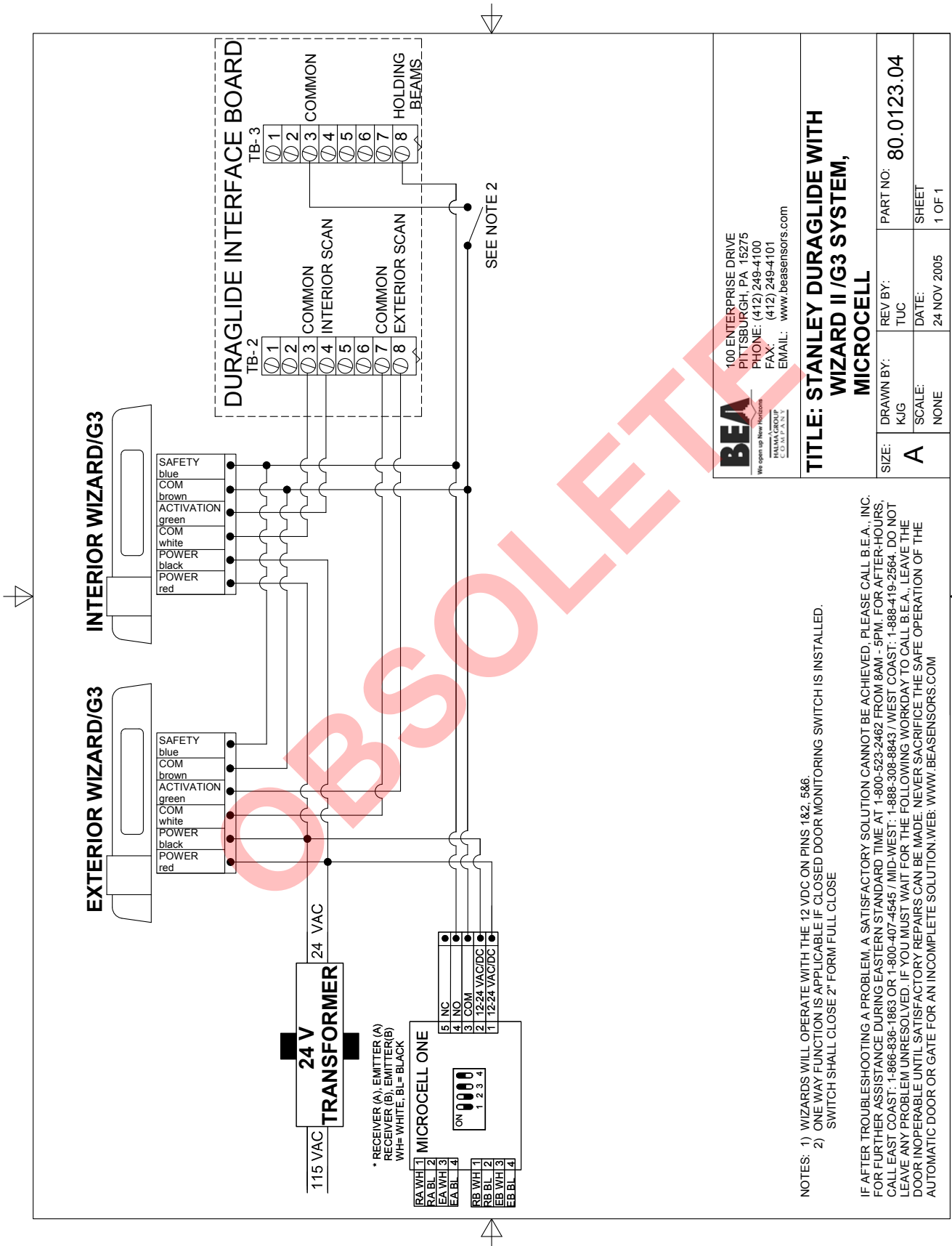

BEA
We open up New Horizons
STANLEY DURAGLIDE COMPANY
100 ENTERPRISE DRIVE
PITTSBURGH, PA 15275
PHONE: (412) 249-4100
FAX: (412) 249-4101
EMAIL: www.beasensors.com

TITLE: STANLEY DURAGLIDE WITH WIZARD II /G3 SYSTEM, MICROCELL

SIZE: A	DRAWN BY: K/G	REV BY: TUC	PART NO: 80.0123.04
SCALE: NONE	DATE: 24 NOV 2005	SHEET 1 OF 1	

NOTES: 1) WIZARDS WILL OPERATE WITH THE 12 VDC ON PINS 1&2 5&6.
2) ONE-WAY FUNCTION IS APPLICABLE IF CLOSED DOOR MONITORING SWITCH IS INSTALLED. SWITCH SHALL CLOSE 2" FORM FULL CLOSE

IF AFTER TROUBLESHOOTING A PROBLEM, A SATISFACTORY SOLUTION CANNOT BE ACHIEVED, PLEASE CALL B.E.A., INC. FOR FURTHER ASSISTANCE DURING EASTERN STANDARD TIME AT 1-800-523-2462 FROM 8AM - 5PM. FOR AFTER-HOURS, CALL EAST COAST: 1-866-636-1663 OR 1-800-407-4945 / MID-WEST: 1-888-308-8843 / WEST COAST: 1-888-419-2664. DO NOT LEAVE ANY PROBLEM UNRESOLVED. IF YOU MUST WAIT FOR THE FOLLOWING WORKDAY TO CALL B.E.A., LEAVE THE DOOR INOPERABLE UNTIL SATISFACTORY REPAIRS CAN BE MADE. NEVER SACRIFICE THE SAFE OPERATION OF THE AUTOMATIC DOOR OR GATE FOR AN INCOMPLETE SOLUTION. WEB: WWW.BEASENSORS.COM

Addendum 2

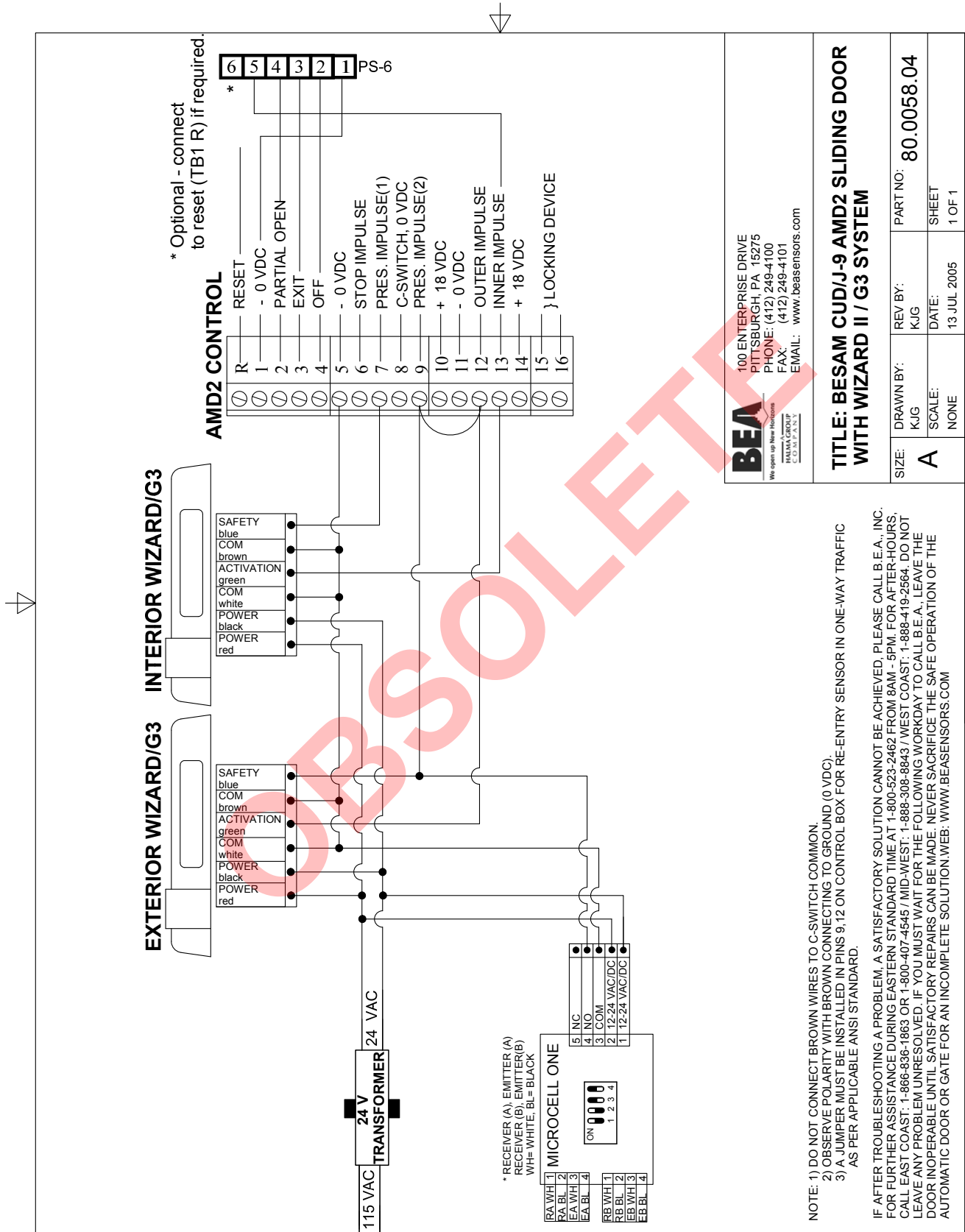

BEA
100 ENTERPRISE DRIVE
PITTSBURGH, PA 15275
PHONE: (412) 249-4100
FAX: (412) 249-4101
EMAIL: www.beasensors.com

TITLE: BESAM CUD/J-9 AMD2 SLIDING DOOR WITH WIZARD II / G3 SYSTEM

SIZE: A	DRAWN BY: K/JG	REV BY: K/JG	PART NO: 80.0058.04
SCALE: NONE	DATE: 13 JUL 2005	SHEET	1 OF 1

NOTE: 1) DO NOT CONNECT BROWN WIRES TO C-SWITCH COMMON.
2) OBSERVE POLARITY WITH BROWN CONNECTING TO GROUND (0 VDC).
3) A JUMPER MUST BE INSTALLED IN PINS 9, 12 ON CONTROL BOX FOR RE-ENTRY SENSOR IN ONE-WAY TRAFFIC AS PER APPLICABLE ANSI STANDARD.

IF AFTER TROUBLESHOOTING A PROBLEM, A SATISFACTORY SOLUTION CANNOT BE ACHIEVED, PLEASE CALL B.E.A. INC. FOR FURTHER ASSISTANCE DURING EASTERN STANDARD TIME AT 1-800-523-2462 FROM 8AM - 5PM. FOR AFTER-HOURS, CALL EAST COAST: 1-866-836-1863 OR 1-800-407-4545 /MID-WEST: 1-888-308-8843 /WEST COAST: 1-888-419-2564. DO NOT LEAVE ANY PROBLEM UNRESOLVED. IF YOU MUST WAIT FOR THE FOLLOWING WORKDAY TO CALL B.E.A., LEAVE THE DOOR INOPERABLE UNTIL SATISFACTORY REPAIRS CAN BE MADE. NEVER SACRIFICE THE SAFE OPERATION OF THE AUTOMATIC DOOR OR GATE FOR AN INCOMPLETE SOLUTION.WEB: WWW.BEASENSORS.COM

Addendum 3

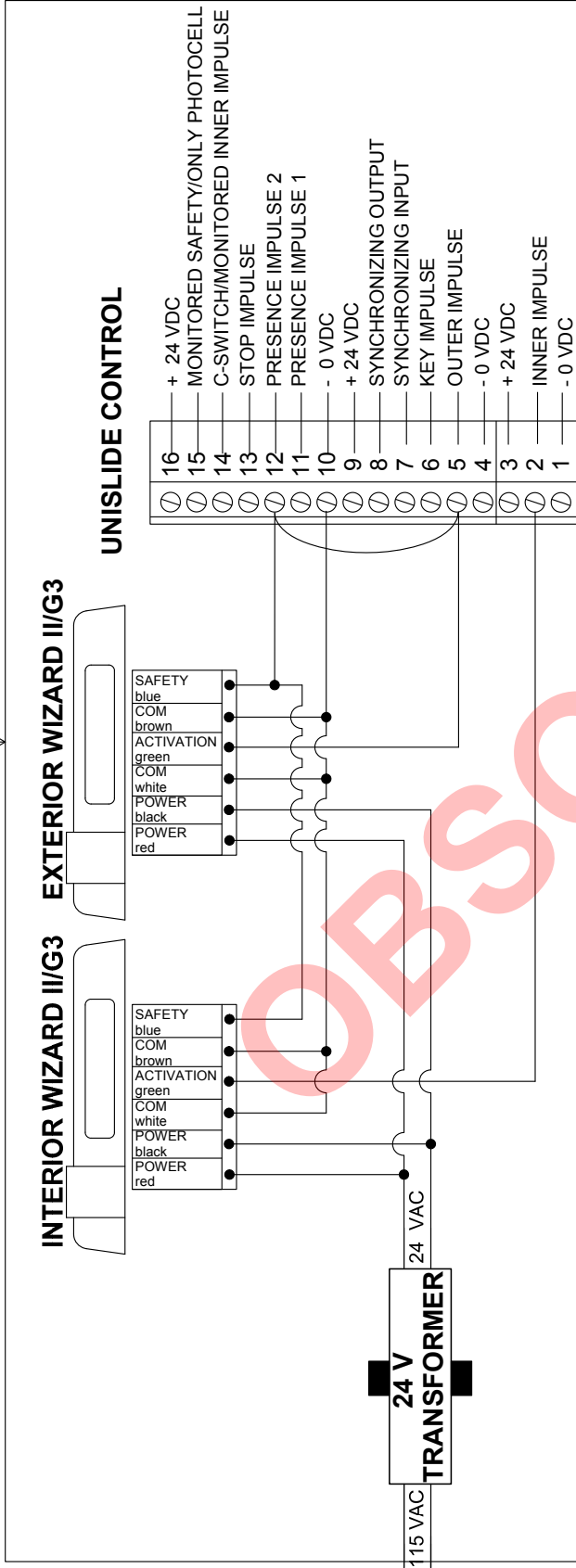

NOTES:

- 1) DO NOT CONNECT BROWN WIRES TO C-SWITCH COMMON.
- 2) OBSERVE POLARITY WITH THE BROWN WIRE CONNECTED TO GROUND (0 VDC).
- 3) A JUMPER MUST BE INSTALLED BETWEEN PINS 5, 12 ON THE CONTROL BOX TO ALLOW FOR RE-ENTRY SENSOR IN ONE-WAY TRAFFIC MODE TO COMPLY WITH ANSI A156.10 SECTION 8.3.3.
- 4) CAN POWER SENSOR FROM CONTROL BOX
- 5) IF REPLACING UL TRAVEIWS W/ WIZARDS SET DIP SW. #7 TO OFF.

IF AFTER TROUBLESHOOTING A PROBLEM, A SATISFACTORY SOLUTION CANNOT BE ACHIEVED, PLEASE CALL B.E.A., INC. FOR FURTHER ASSISTANCE DURING EASTERN STANDARD TIME AT 1-800-523-2462 FROM 8AM - 5PM. FOR AFTER-HOURS, CALL EAST COAST: 1-866-836-1863 OR 1-800-407-4545 / MID-WEST: 1-888-308-8843 / WEST COAST: 1-888-419-2564. DO NOT LEAVE ANY PROBLEM UNRESOLVED. IF YOU MUST WAIT FOR THE FOLLOWING WORKDAY TO CALL B.E.A., LEAVE THE DOOR INOPERABLE UNTIL SATISFACTORY REPAIRS CAN BE MADE. NEVER SACRIFICE THE SAFE OPERATION OF THE AUTOMATIC DOOR OR GATE FOR AN INCOMPLETE SOLUTION. WEB: WWW.BEASENSORS.COM

BEA
 We open up New Horizons
 HAKMA GROUP
 COMPANY
 100 ENTERPRISE DRIVE
 PITTSBURGH, PA 15275
 PHONE: (412) 249-4100
 FAX: (412) 249-4101
 EMAIL: www.beasensors.com

TITLE: BESAM UNISLIDE SLIDING DOOR WITH WIZARD II / G3 SYSTEM

SIZE: A	DRAWN BY: K/JG	REV BY: TUC	PART NO: 80.0163.04
SCALE: NONE	DATE: 30 NOV 2005	SHEET: 1 OF 1	

Addendum 4

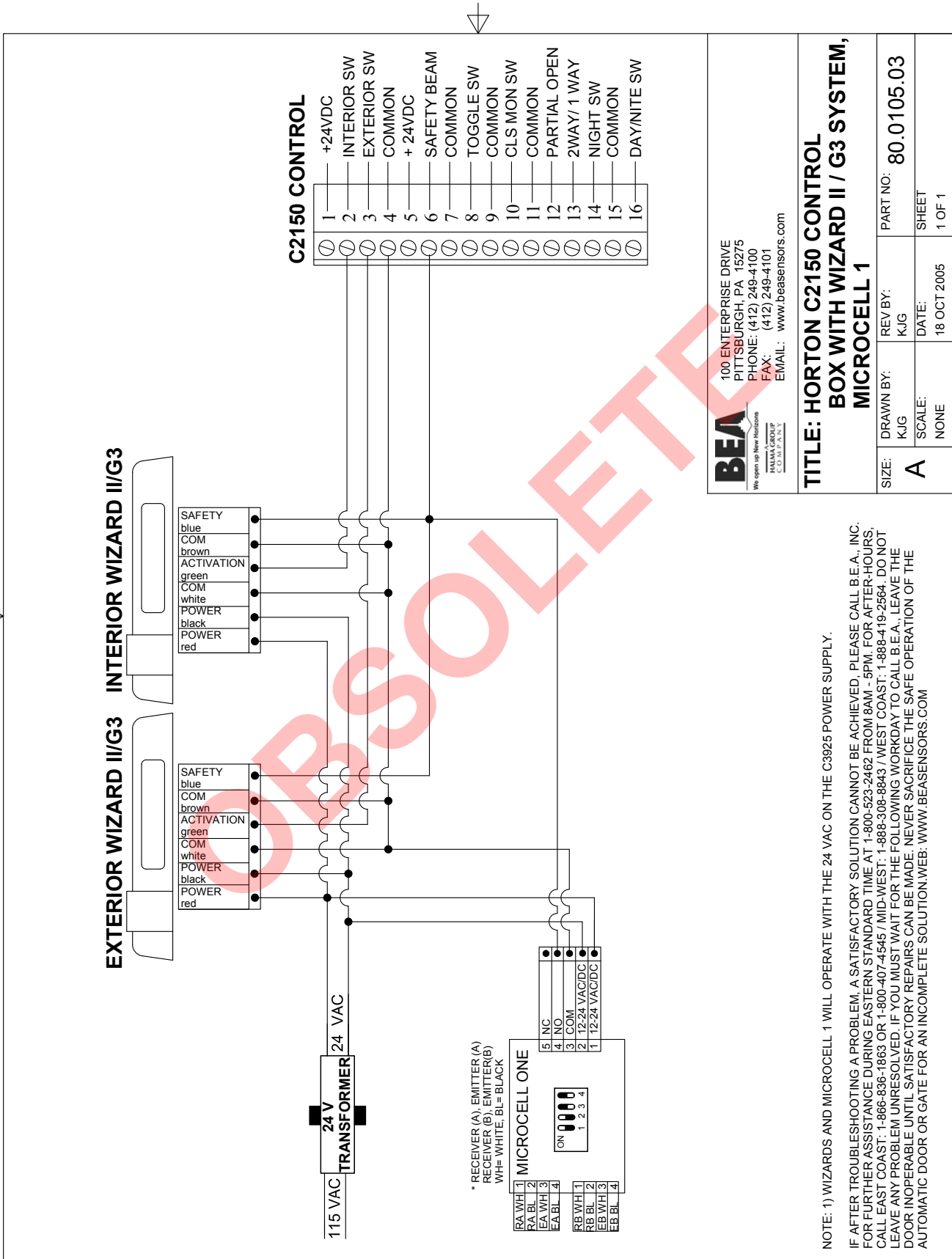

BEA
100 ENTERPRISE DRIVE
PITTSBURGH, PA 15275
PHONE: (412) 249-4100
FAX: (412) 249-4101
EMAIL: www.beasensors.com

We open up New Horizons
BEA SENSORS COMPANY

TITLE: HORTON C2150 CONTROL BOX WITH WIZARD II / G3 SYSTEM, MICROCELL 1

SIZE: A	DRAWN BY: K/JG	REV BY: K/JG	PART NO: 80.0105.03
SCALE: NONE	DATE: 18 OCT 2005	SHEET: 1 OF 1	

Addendum 5

Did you know?

The G3 has two simple choices for active infrared immunity, Normal and High. High immunity may be used in highly reflective applications or in extreme cases of snow, rain, pedimats or lighting.

Intelli-tracking, which is built into the G3's core software, reduces challenges and service calls in the field!

One way night mode / secondary activation, can be used to meet ANSI for activation at 43" and then at 24" with a flip of a switch by the end user.

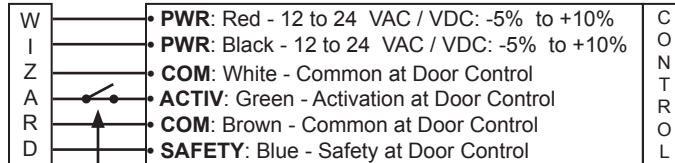

One way evening mode: Switch on ACTIVATION Line!

One way night mode / secondary activation: Activation has two zones (i) inner zone with 24" adjustable pattern depth which outputs on the safety circuit (brown and blue wires); (ii) outer full zone with 43" adjustable pattern depth which outputs on the activation circuit (white and green wires). By cutting the activation circuit with a switch, only the inner 24" zone is active. Because this is on the safety circuit, the inner zone is only active when the door is in-motion or open.

When performing service the G3 can hold the door permanently open using the F2 function.

The G3 is for use in all of North America. No special part numbers for Canada are needed.



To change to "High" Infrared Immunity press:



To hold the door open during service press:



To set the sensor to normal state press:

