

NOTE: 1) ENSURE THAT A MINIMUM OF 3 SECONDS OF HOLD OPEN TIME IS LEFT ON THE LE-21.

IF AFTER TROUBLESHOOTING A PROBLEM, A SATISFACTORY SOLUTION CANNOT BE ACHIEVED, PLEASE CALL B.E.A., INC. FOR FURTHER ASSISTANCE DURING EASTERN STANDARD TIME AT 1-800-523-2462 FROM 8AM - 5PM. FOR AFTER-HOURS, CALL EAST COAST: 1-866-836-1863 OR 1-800-407-4545 / MID-WEST: 1-888-308-8843 / WEST COAST: 1-888-419-2564. DO NOT LEAVE ANY PROBLEM UNRESOLVED. IF YOU MUST WAIT FOR THE FOLLOWING WORKDAY TO CALL B.E.A., LEAVE THE DOOR INOPERABLE UNTIL SATISFACTORY REPAIRS CAN BE MADE. NEVER SACRIFICE THE SAFE OPERATION OF THE AUTOMATIC DOOR OR GATE FOR AN INCOMPLETE SOLUTION. WEB: WWW.BEASENSORS.COM

		100 ENTERPRISE DRIVE PITTSBURGH, PA 15275 PHONE: (412) 249-4100 FAX: (412) 249-4101 EMAIL: www.beasensors.com	
TITLE: TORMAX TTX CONTROL WITH SUPERSCAN, MC15, BODYGUARD, EAGLE, PUSHPLATE			
SIZE: B	DRAWN BY: KJG	REV BY: TUC	PART NO: 80.0112.04
SCALE: NONE	DATE: 24 OCT 2005	SHEET 1 OF 1	

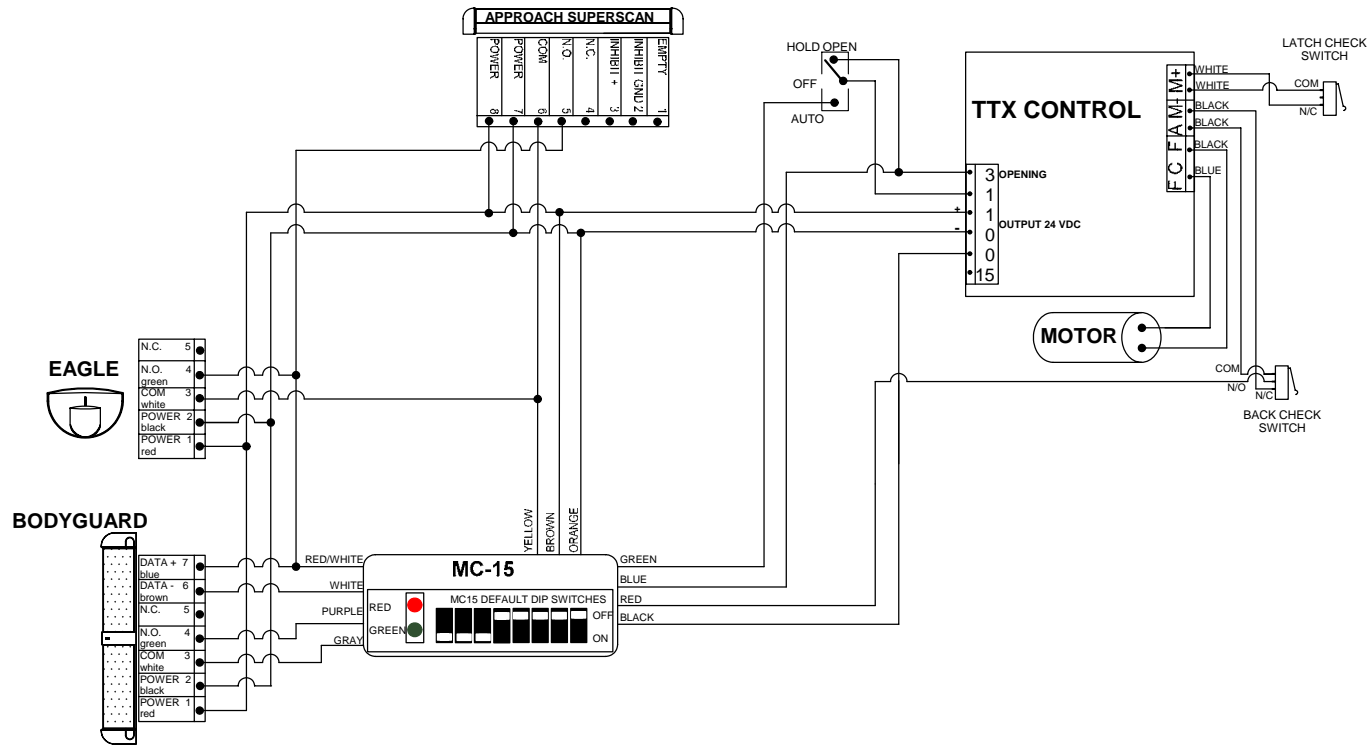

NOTE: 1) ENSURE THAT A MINIMUM OF 3 SECONDS OF HOLD OPEN TIME TO EACH EAGLE AND SUPERSCAN. THIS IS NEEDED TO GET THE DOOR TO BACK CHECK.

IF AFTER TROUBLESHOOTING A PROBLEM, A SATISFACTORY SOLUTION CANNOT BE ACHIEVED, PLEASE CALL B.E.A., INC. FOR FURTHER ASSISTANCE DURING EASTERN STANDARD TIME AT 1-800-523-2462 FROM 8AM - 5PM. FOR AFTER-HOURS, CALL EAST COAST: 1-866-836-1863 OR 1-800-407-4545 / MID-WEST: 1-888-308-8843 / WEST COAST: 1-888-419-2564. DO NOT LEAVE ANY PROBLEM UNRESOLVED. IF YOU MUST WAIT FOR THE FOLLOWING WORKDAY TO CALL B.E.A., LEAVE THE DOOR INOPERABLE UNTIL SATISFACTORY REPAIRS CAN BE MADE. NEVER SACRIFICE THE SAFE OPERATION OF THE AUTOMATIC DOOR OR GATE FOR AN INCOMPLETE SOLUTION. WEB: WWW.BEASENSORS.COM

		100 ENTERPRISE DRIVE PITTSBURGH, PA 15275 PHONE: (412) 249-4100 FAX: (412) 249-4101 EMAIL: www.beasensors.com	
TITLE: TORMAX TTX CONTROL WITH SUPERSCAN, MC15, BODYGUARD, EAGLE			
SIZE:	DRAWN BY:	REV BY:	PART NO:
B	KJG	TUC	80.0113.04
SCALE:	DATE:	SHEET	
NONE	24 OCT 2005	1 OF 1	

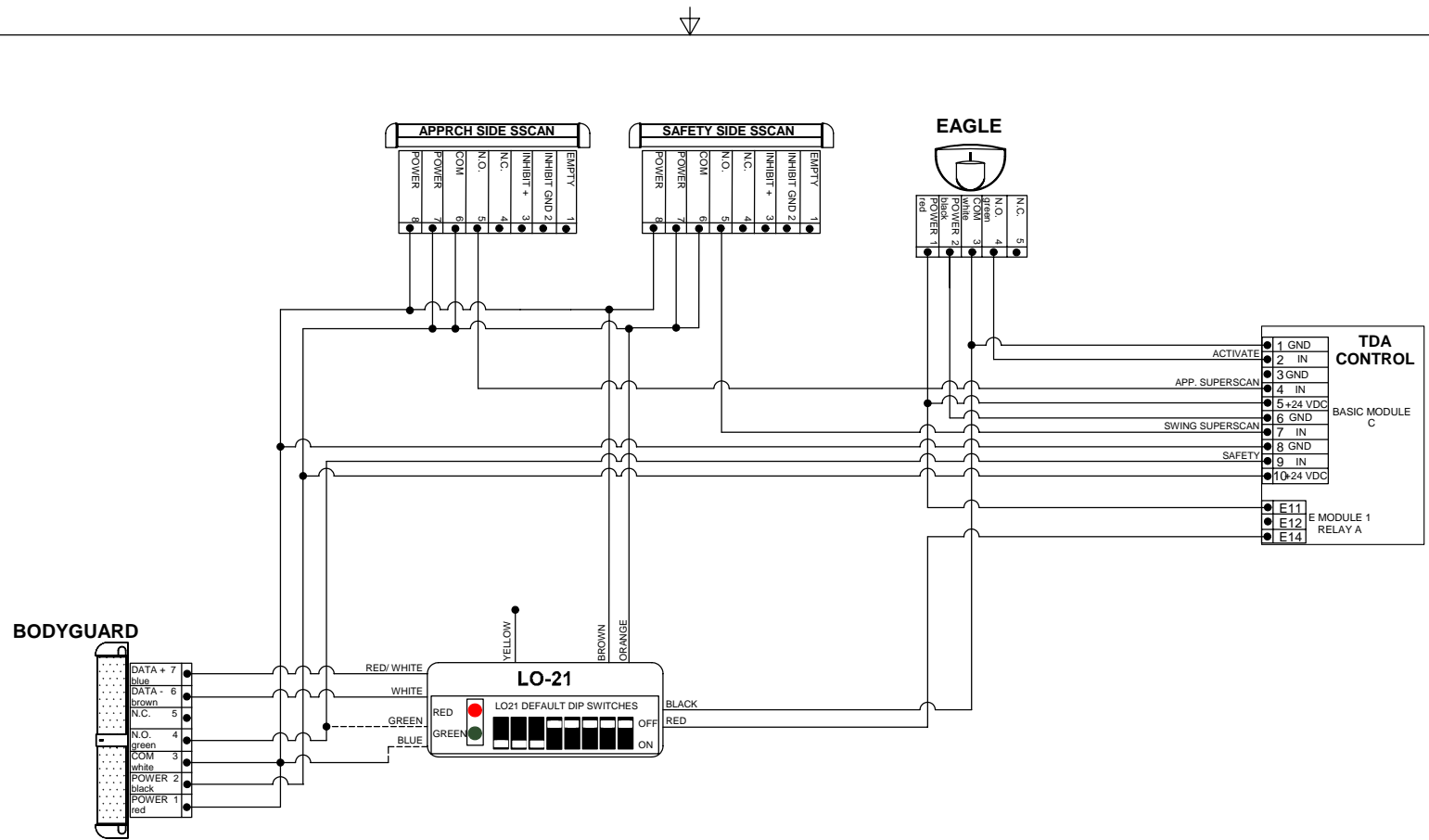

NOTE: 1) CONNECT THE LO21 DASHED LINES (GREEN, BLUE, BLACK/ WHITE, PURPLE, GRAY) ONLY IF SAFETY BEAMS ARE USED.

IF AFTER TROUBLESHOOTING A PROBLEM, A SATISFACTORY SOLUTION CANNOT BE ACHIEVED, PLEASE CALL B.E.A., INC. FOR FURTHER ASSISTANCE DURING EASTERN STANDARD TIME AT 1-800-523-2462 FROM 8AM - 5PM. FOR AFTER-HOURS, CALL EAST COAST: 1-866-836-1863 OR 1-800-407-4545 / MID-WEST: 1-888-308-8843 / WEST COAST: 1-888-419-2564. DO NOT LEAVE ANY PROBLEM UNRESOLVED. IF YOU MUST WAIT FOR THE FOLLOWING WORKDAY TO CALL B.E.A., LEAVE THE DOOR INOPERABLE UNTIL SATISFACTORY REPAIRS CAN BE MADE. NEVER SACRIFICE THE SAFE OPERATION OF THE AUTOMATIC DOOR OR GATE FOR AN INCOMPLETE SOLUTION.WEB: WWW.BEASENSORS.COM

		100 ENTERPRISE DRIVE PITTSBURGH, PA 15275 PHONE: (412) 249-4100 FAX: (412) 249-4101 EMAIL: www.beasensors.com	
TITLE: TORMAX TTA CONTROL WITH PARALLAX 1 SYSTEM (LO-21)			
SIZE:	DRAWN BY:	REV BY:	PART NO:
B	KJG	TUC	80.0114.01
SCALE:	DATE:	SHEET	
NONE	14 NOV 2005	1 OF 1	

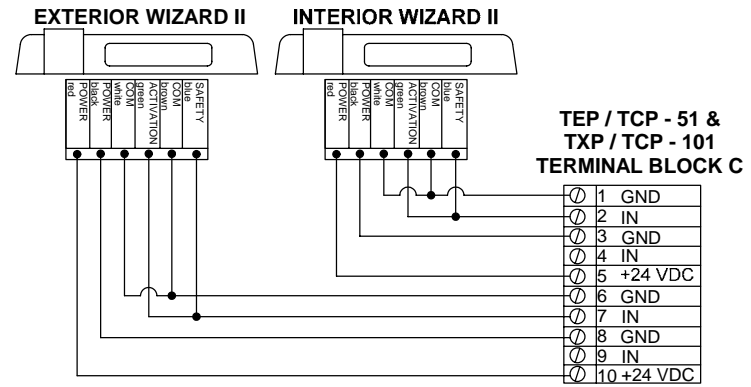
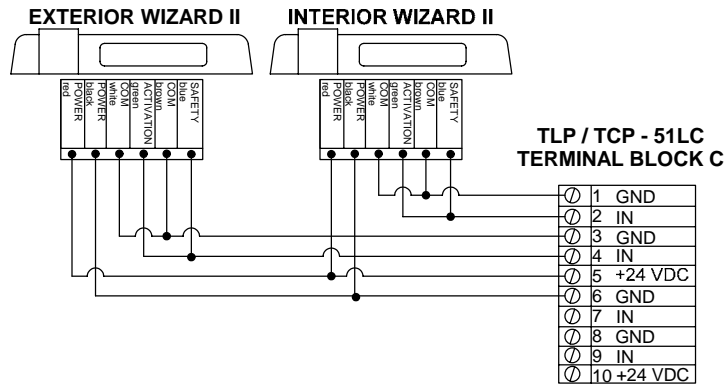

NOTE: SAFETY OUTPUT RE-DIRECTION MUST BE CHANGED FOR THIS CONFIGURATION. USING THE UNIVERSAL REMOTE SELECT UNLOCK, F1, 1, LOCK, LOCK.

IF AFTER TROUBLESHOOTING A PROBLEM, A SATISFACTORY SOLUTION CANNOT BE ACHIEVED, PLEASE CALL B.E.A., INC. FOR FURTHER ASSISTANCE DURING EASTERN STANDARD TIME AT 1-800-523-2462 FROM 8AM - 5PM. FOR AFTER-HOURS, CALL EAST COAST: 1-866-836-1863 OR 1-800-407-4545 / MID-WEST: 1-888-308-8843 / WEST COAST: 1-888-419-2564. DO NOT LEAVE ANY PROBLEM UNRESOLVED. IF YOU MUST WAIT FOR THE FOLLOWING WORKDAY TO CALL B.E.A., LEAVE THE DOOR INOPERABLE UNTIL SATISFACTORY REPAIRS CAN BE MADE. NEVER SACRIFICE THE SAFE OPERATION OF THE AUTOMATIC DOOR OR GATE FOR AN INCOMPLETE SOLUTION. WEB: WWW.BEASENSORS.COM

 <small>We speak up New Horizons.</small> <small>BEA GROUP</small> <small>EST. 1978</small>	100 ENTERPRISE DRIVE PITTSBURGH, PA 15275 PHONE: (412) 249-4100 FAX: (412) 249-4101 EMAIL: www.beasensors.com		
	TITLE: TORMAX SLIDING DOOR WITH WIZARD II SYSTEM		
SIZE: B	DRAWN BY: KJG	REV BY: TUC	PART NO: 80.0115.04
SCALE: NONE	DATE: 14 NOV 2005	SHEET 1 OF 1	

EAGLE

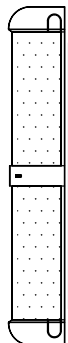
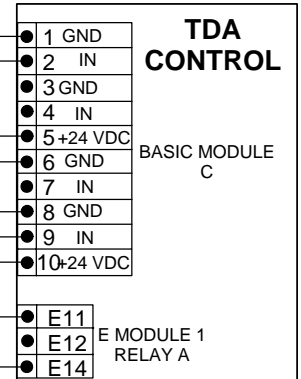
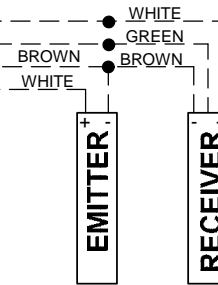
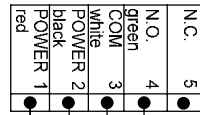
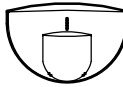

BODYGUARD

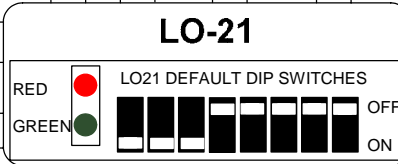

NOTES: Connect the dashed lines (green, blue, black/ white, purple & gray) ONLY if safety beams are used. If Dry Contact Safety Beams are used wire N.O. & Com. to purple & gray respectively.

IF AFTER TROUBLESHOOTING A PROBLEM, A SATISFACTORY SOLUTION CANNOT BE ACHIEVED, PLEASE CALL B.E.A., INC. FOR FURTHER ASSISTANCE DURING EASTERN STANDARD TIME AT 1-800-523-2462 FROM 8AM - 5PM. FOR AFTER-HOURS, CALL EAST COAST: 1-866-836-1863 OR 1-800-407-4545 / MID-WEST: 1-888-308-8843 / WEST COAST: 1-888-419-2564. DO NOT LEAVE ANY PROBLEM UNRESOLVED. IF YOU MUST WAIT FOR THE FOLLOWING WORKDAY TO CALL B.E.A., LEAVE THE DOOR INOPERABLE UNTIL SATISFACTORY REPAIRS CAN BE MADE. NEVER SACRIFICE THE SAFE OPERATION OF THE AUTOMATIC DOOR OR GATE FOR AN INCOMPLETE SOLUTION. WEB: WWW.BEASENSORS.COM

BEA
 We open up New Horizons
 HALMA GROUP COMPANY
 100 ENTERPRISE DRIVE
 PITTSBURGH, PA 15275
 PHONE: (412) 249-4100
 FAX: (412) 249-4101
 EMAIL: www.beasensors.com

TITLE: TORMAX TDA SINGLE WITH DK-12/ BODYGUARD w/LO-21

SIZE: A	DRAWN BY: KJG	REV BY: TUC	PART NO: 80.0116.03
	SCALE: NONE	DATE: 21 NOV 2005	SHEET 1 OF 1

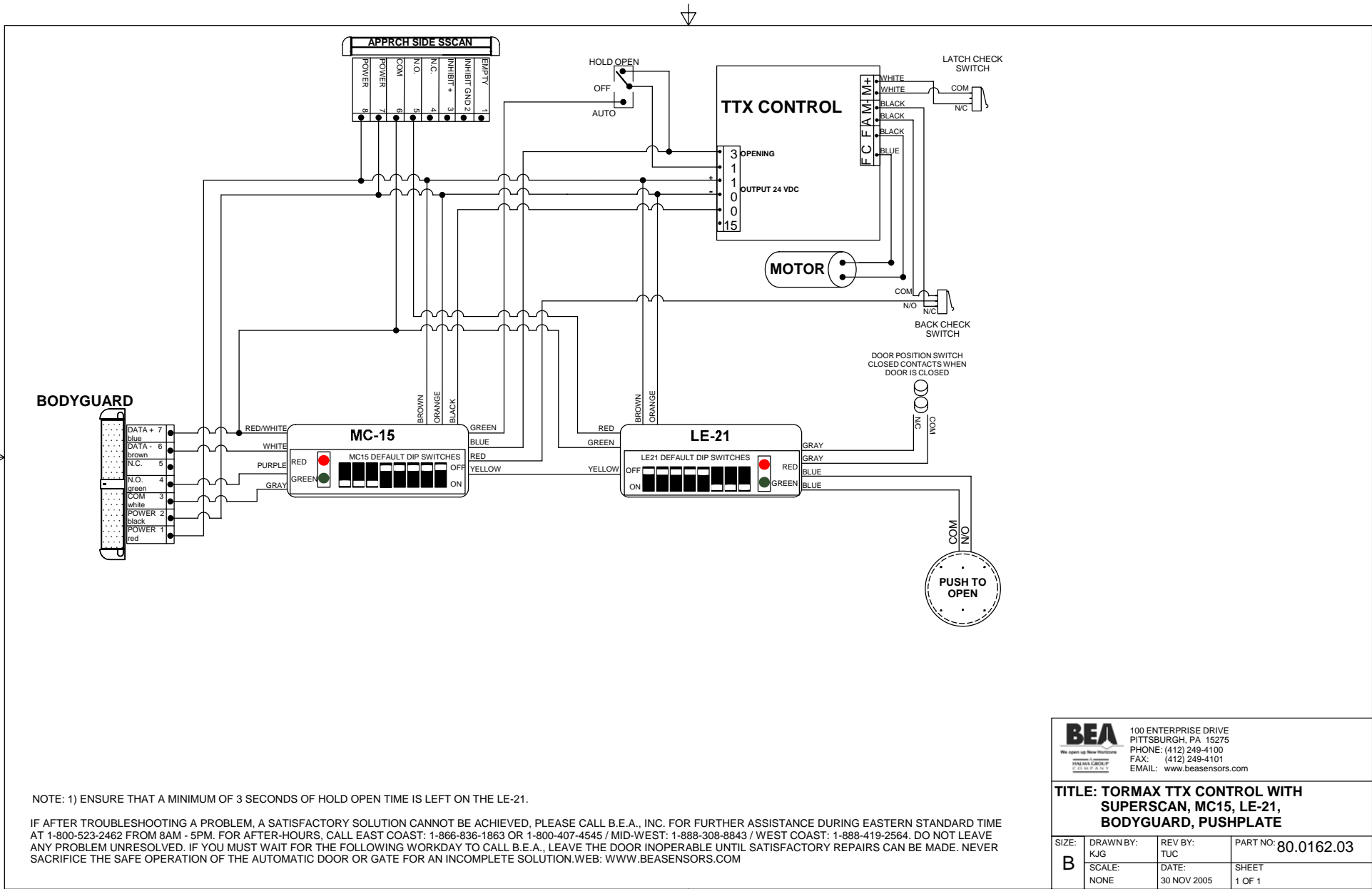

		100 ENTERPRISE DRIVE PITTSBURGH, PA 15275 PHONE: (412) 249-4100 FAX: (412) 249-4101 EMAIL: www.beasensors.com	
TITLE: TORMAX TTX CONTROL WITH SUPERSCAN, MC15, LE-21, BODYGUARD, PUSHPLATE			
SIZE:	DRAWN BY:	REV BY:	PART NO:
B	KJG	TUC	80.0162.03
SCALE:	DATE:	SHEET	
NONE	30 NOV 2005	1 OF 1	

EAGLE

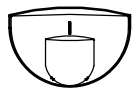

BODYGUARD

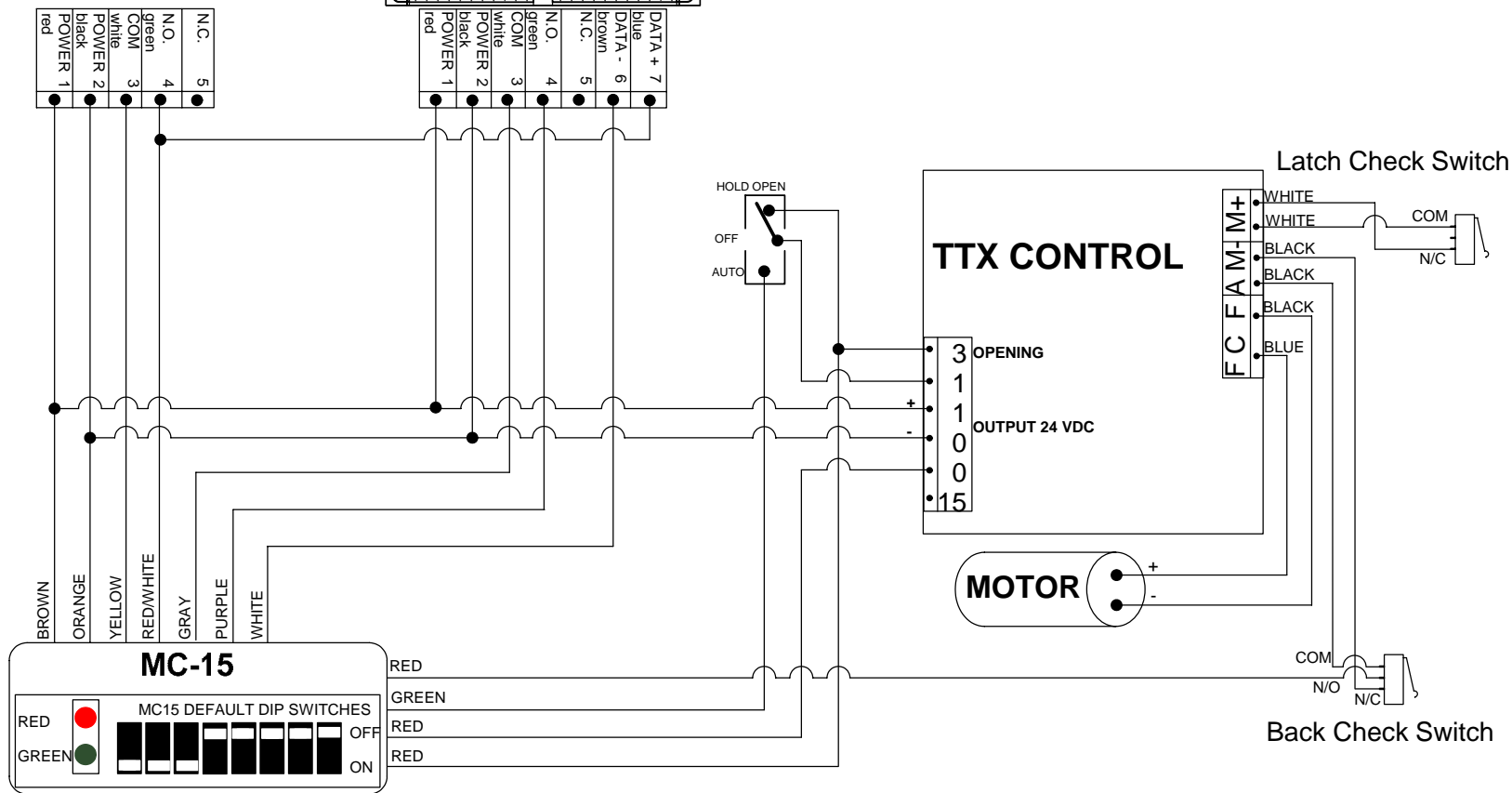
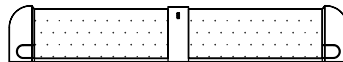

BEA
 We open up New Horizons
 HALMA GROUP COMPANY
 100 ENTERPRISE DRIVE
 PITTSBURGH, PA 15275
 PHONE: (412) 249-4100
 FAX: (412) 249-4101
 EMAIL: www.beasensors.com

TITLE: TORMAX TTX CONTROL WITH MC15, BODYGUARD EAGLE

IF AFTER TROUBLESHOOTING A PROBLEM, A SATISFACTORY SOLUTION CANNOT BE ACHIEVED, PLEASE CALL B.E.A., INC. FOR FURTHER ASSISTANCE DURING EASTERN STANDARD TIME AT 1-800-523-2462 FROM 8AM - 5PM. FOR AFTER-HOURS, CALL EAST COAST: 1-866-836-1863 OR 1-800-407-4545 / MID-WEST: 1-888-308-8843 / WEST COAST: 1-888-419-2564. DO NOT LEAVE ANY PROBLEM UNRESOLVED. IF YOU MUST WAIT FOR THE FOLLOWING WORKDAY TO CALL B.E.A., LEAVE THE DOOR INOPERABLE UNTIL SATISFACTORY REPAIRS CAN BE MADE. NEVER SACRIFICE THE SAFE OPERATION OF THE AUTOMATIC DOOR OR GATE FOR AN INCOMPLETE SOLUTION. WEB: WWW.BEASENSORS.COM

SIZE: A	DRAWN BY: TUC	REV BY: TUC	PART NO: 80.0200.01
	SCALE: NONE	DATE: 05 DEC 2005	SHEET 1 OF 1

LO-LINX SWING	GREEN ACT.	WHITE COM.	YELLOW SAF.	BLUE STALL	BROWN STAL COM.
BESAM 300	13	12	11	15, 17	16, 18
BESAM M/P	3	4	9	5	13
DOM	YELLOW	GREY	BLUE	PURPLE	GREY
GT 300/400	BLACK	RED	WHITE	WHITE	RED
GT MAG	6 BLACK	5 RED	4 WHITE	3 VIOLET	5 RED
HORTON 4190	2	3, 6, 8	4	10	3, 6, 8
HUNTER	ACT.	RTN	SAF. 1	SAF. 2	RTN
KM K	GREEN	WHITE	RED	YELLOW	WHITE
STANLEY "L"	ORANGE	YELLOW	RED	BLUE	YELLOW
STANLEY M/P	2	1, 8	7	7	1, 8
STANLEY 521	TB4-4	TB4-3	TB3-8	TB3-4	TB3-3
TORMAX TTXII	5	4	13	14	15

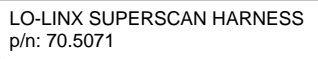
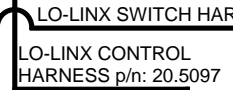
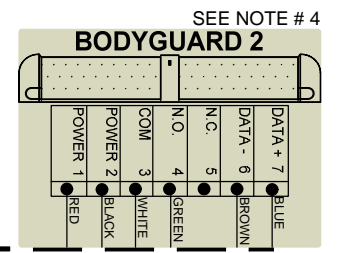
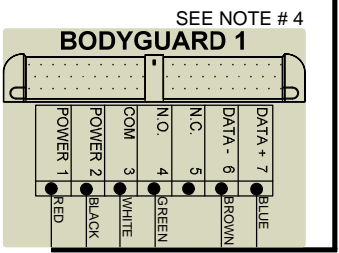
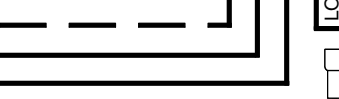
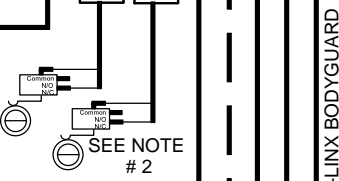
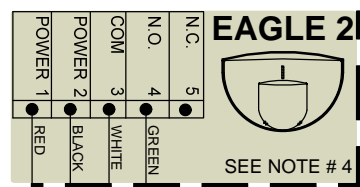
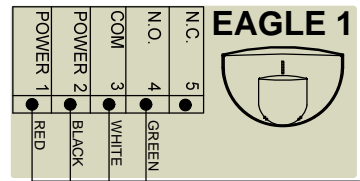
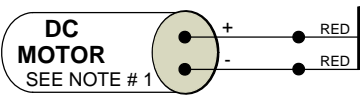
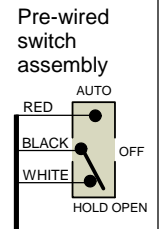
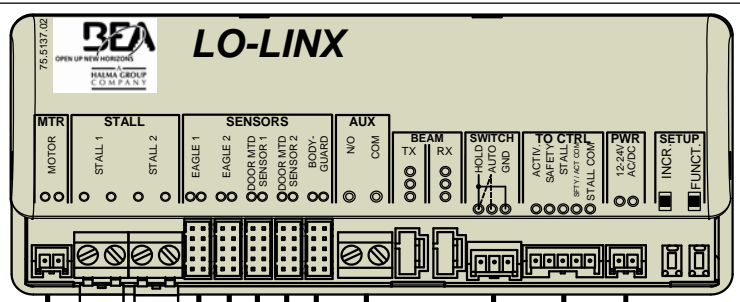

1 IN	OFF
2 GND	AUTO
3 IN	OPEN
4 GND	
5 IN	ACT.
6 24+	
7 GND	
8 IN	
9 OUT	
10 24+	
11 OUT	DOOR STATUS
12 24V+V	
13 GND	
14 IN	SWING
15 OUT	SIDE SAFETY
17 GND	
18 IN	BODYGUARD
19 OUT	SAFETY
20 +24V	

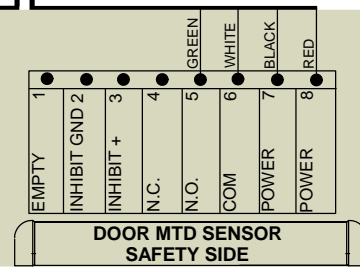
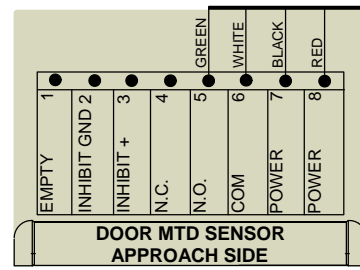
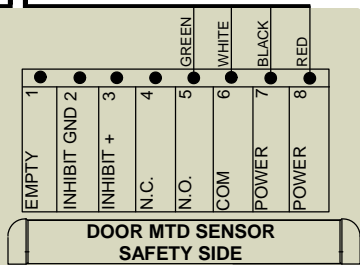
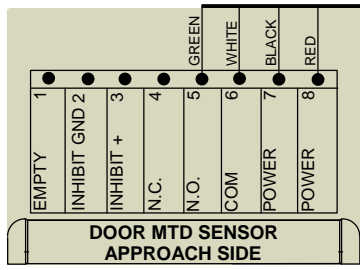

- NOTES:
1. MOTOR CONNECTION IS TIED IN PARALLEL TO EXISTING MOTOR LEADS. NO RESPECT TO PALARITY IS REQUIRED.
 2. EXTERNAL SWITCHES ARE REQUIRED IF INHIBIT DESIRED AT SWING SIDE SUPERSCANS, SWITCH OPENS UPON INHIBIT POINT.
 3. THE KNOWING ACT SWITCH IS CONNECTED AT THE AUX INPUT AND CAN BE ANY DRY CONTACT DEVICE SUCH AS A PUSHPLATE, CARD READER, ETC. THE AUX INPUT IS REQUIRED FOR ALL INITIAL ACTIVATION WHEN FUNCTION 'FA' ON THE LO-LINX IS SET TO '01'.
 4. THE SECOND BODYGUARD AND EAGLE ARE PRIMARILY USED IN DUAL-EGRESS APPLICATIONS. ENSURE BODYGUARD RELAY VALUE IS SET TO 2.

IF AFTER TROUBLESHOOTING A PROBLEM, A SATISFACTORY SOLUTION CANNOT BE ACHIEVED, PLEASE CALL B.E.A., INC. FOR FURTHER ASSISTANCE DURING EASTERN STANDARD TIME AT 1-800-523-2462 FROM 8AM - 5PM. FOR AFTER-HOURS, CALL EAST COAST: 1-866-836-1863 OR 1-800-407-4545 / MID-WEST: 1-888-308-8843 / WEST COAST: 1-888-419-2564. DO NOT LEAVE ANY PROBLEM UNRESOLVED. IF YOU MUST WAIT FOR THE FOLLOWING WORKDAY TO CALL B.E.A., LEAVE THE DOOR INOPERABLE UNTIL SATISFACTORY REPAIRS CAN BE MADE. NEVER SACRIFICE THE SAFE OPERATION OF THE AUTOMATIC DOOR OR GATE FOR AN INCOMPLETE SOLUTION. WEB: WWW.BEASENSORS.COM

BEA
OPEN UP NEW HORIZONS
HALMA GROUP COMPANY

100 ENTERPRISE DRIVE
PITTSBURGH, PA 15275
PHONE: (412) 249-4100
FAX: (412) 249-4101
EMAIL: www.beasensors.com

TITLE: TORMAX-TTXII LO-LINX SYSTEM

SIZE: A	DRAWN BY: JED	REV BY: TUC	PART NO: 80.0289.01
SCALE: NONE	DATE: 10/15/2007	SHEET 1 OF 1	